



**GREEN GAS LIMITED
(A Joint Venture of GAIL and IOCL)**

**CITY GAS DISTRIBUTION PROJECT
LUCKNOW AND AGRA**

**VOLUME II OF II (TECHNICAL)
BID DOCUMENT FOR PROCUREMENT OF
PE PIPES
(BID DOCUMENT NO 110326/WGI/GGL/05-R0)**

LIMITED DOMESTIC COMPETITIVE BIDDING





DELIVERS. EVOLVES.

WHOLE LIFE SOLUTIONS FOR PIPELINE AND SUBSEA SYSTEMS

ISSUED BY



	<u>TABLE OF CONTENT</u>	
---	--------------------------------	---

S.NO.	DOCUMENT	DOCUMENT NO.	PAGES
	VOLUME – II OF II		
1.	Material Requisition for PE pipes	11-0326-02-07-06-001	6
2.	Polyethylene Pipes for Underground Networks for Natural Gas Distribution General Requirements	11-0326-02-07-02-001	23
3.	Polyethylene Pipes for Underground Networks for Natural Gas Distribution - Technical Datasheet	11-0326-02-07-02-002	5
4.	Polyethylene Pipes for Underground Networks for Natural Gas Distribution - Quality Control of Pipes	11-0326-02-07-02-003	19
5.	PE Accessories for Underground Networks for Natural Gas Distribution	11-0326-02-07-02-004	20
6.	Polyethylene Compounds for Manufacture of Pipes and Fittings for Underground Networks for Natural Gas Distribution Acceptance Procedure	11-0326-02-07-02-005	12
7.	Supplementary Procedure for Type Approval of Polyethylene Pipes for Underground Gas Networks	11-0326-02-07-02-007	14
8.	Polyethylene Pipes	11-0326-02-07-02-024	5

Index



**GREEN GAS LIMITED
CITY GAS DISTRIBUTION**



MATERIAL REQUISITION FOR PROCUREMENT OF PE PIPES					CLIENT JOB NO.	-
					TOTAL SHEETS	6
DOCUMENT NO	11	0326	02	07	06	001

--	--	--	--	--	--

0	30.12.11	ISSUED FOR TENDER	PD	SSJ	SB
A	16.11.11	ISSUED FOR CLIENT COMMENTS	PD	SSJ	SB
REV	DATE	DESCRIPTION	PREP	CHK	APPR

TABLE OF CONTENT

1. SCOPE OF SUPPLY..... 3

2. REMARKS..... 3

3. SPECIAL INSTRUCTIONS TO BIDDER..... 4

4. INFORMATION/ DOCUMENTS/ DRWGS TO BE SUBMITTED BY SUCCESSFUL BIDDER... 4

5. LIST OF RECOMMENDED TPI AGENCIES..... 6



MATERIAL REQUISITION
PROCUREMENT OF PE PIPES

Document No.

Rev

11- 0326-02-07- 06- 001

0

SHEET 2 of 6

1.0 SCOPE OF SUPPLY

This Specification covers, supply of PE pipes to be used in City Gas Distribution for Lucknow & Agra City in the state of Uttar Pradesh.

The scope of supply covers design, engineering, manufacture, inspection, testing, supply & documentation requirements of these items in accordance with the requirements of prEN1555-1 or IS: 14885 and Technical specifications.

S. No.	Description				Length of pipes	Quantity(m)	
	Size(OD)mm	Grade of material	Minimum Wall Thickness(mm)	Standard Dimension Ratio(SDR)		Agra	Lucknow
1	125 dia	PE100	11.4	11	coil of 50 m length	1000	8000
2	90 dia	PE100	8.2	11	coil of 50 m length	4000	4500
3	63 dia	PE100	5.8	11	coil of 100 m length	12000	17000
4	32 dia	PE100	3	11	coil of 100 m length	65000	24000
5	20 dia	PE100	2	11	coil of 100 m length	20000	15000

Delivery Period for Item No. 1 to 6

Description	Delivery
Indian Bidder	12 weeks
Foreign Bidder	NA

2.0 REMARKS

2.1 Supplier's Compliance

Supplier shall submit his bid in full compliance with the requirements of this MR and attachments. Bidder shall include the following statement in his bid:

We certify that our bid is fully complying with your enquiry dated and referenced

Compliance with this material Requisition in any instance shall not relieve the Vendor of his responsibility to meet the specified performance.

2.2 Compliance with Specification

The supplier shall be completely responsible for the design, materials, fabrication, testing, and



**MATERIAL REQUISITION
PROCUREMENT OF PE PIPES**

Document No.

11- 0326-02-07- 06- 001

SHEET 3 of 6

Rev

0

Inspection, preparation for shipment & transfer of above material to nominated delivery point strictly in accordance with the MR & all attachments thereto.

2.3 Supplier's Scope

The scope of supply covers design, engineering, manufacture, inspection, testing, supply & documentation requirements of these items in accordance with the requirements of prEN1555-1 or IS: 14885 and Technical specifications.

2.4 Inspection

Supplier shall submit with his bid a list of 3 well known international Third Party inspection Agencies as per enclosed list (Sheet 6 of 6), which he intends to use for inspection. This agency will issue all relevant certificates as per specification & codes.

Inspection shall also be performed by a designated Third Party Inspection agency and/or purchaser as set out & specified in the codes & particular documents forming this MR.

3.0 SPECIAL INSTRUCTIONS TO BIDDERS

3.1 Bidder to note that no correspondence shall be entered into or entertained after the bid submission.

3.2 Bidder shall furnish quotation only in case he can supply material strictly as per this Material Requisition and specification/data sheets forming part of Material Requisition & Technical Specification.

3.3 If the offer contains any technical deviations or clarifications or stipulates any technical specifications (even if in line with MR requirements) and does not include complete scope & technical/ performance data required to be submitted with the offer, the offer shall be liable for rejection.

3.4 The submission of prices by the Bidder shall be construed to mean that he has confirmed compliance with all technical specifications of the corresponding item(s).

3.5 Supplier must note that stage wise inspection for complete fabrication, testing including raw material inspection to be carried out.

3.6 All material shall be delivered at Company's designated storage yard. The destination for delivery of items is at Lucknow & Agra City in the state of Uttar Pradesh

4.0 INFORMATION/ DOCUMENTS / DRAWINGS TO BE SUBMITTED BY SUCCESSFUL BIDDER

Successful Bidder shall submit 3 copies unless noted otherwise, each of the following:

4.1 Inspection & test reports for all mandatory tests as per the applicable code as well as test reports for any supplementary tests, in nicely bound volumes.

4.2 Material test certificates (physical property, chemical composition, make, heat treatment report, etc.) as applicable for items in nicely bound volumes.

4.3 Statutory test certificates, as applicable.

4.4 Filled in Quality Assurance Plan (QAP) for Purchaser's/ Consultant's approval. These QAPs shall be submitted in four copies within 15 days from LOI/ FOI.

4.5 Detailed completion schedule activity wise (Bar Chart), within one week of placement of order.

4.6 Weekly & fortnightly progress reports for all activities including procurement.



**MATERIAL REQUISITION
PROCUREMENT OF PE PIPES**

Document No.

Rev

11- 0326-02-07- 06- 001

0

SHEET 4 of 6

4.7 All approved drawings/ design calculation/ maintenance/ operating manual documents as well as inspection and test reports for Owner's/ Consultants reference/ record in nicely category-wise bound volumes separately in 6 copies.

4.8 A list of documents to be furnished along with supply.

Note: All drawings, instructions, catalogues, etc., shall be in English language and all dimensions shall be metric units.



**MATERIAL REQUISITION
PROCUREMENT OF PE PIPES**

Document No.

Rev

11- 0326-02-07- 06- 001

0

SHEET 5 of 6

5.0 LIST OF RECOMMENDED TPI AGENCIES

S.NO	NAME OF TPI AGENCY
1	Tata Projects Ltd.
2	Indian Register of Shipping
3	Bax counsel Insepection Bureau Pvt. Ltd.
4	Bureau VeritasQI
5	Germanischer Lloyd
6	Velosi Certification Services,Mumbai
7	ABS Industrial Verification Ltd., Mumbai
8	Certification Engineers International Ltd.
9	Dalal Mott MacDonald
10	International Certification Systems
11	SGS



**MATERIAL REQUISITION
PROCUREMENT OF PE PIPES**



Document No.

Rev

11- 0326-02-07- 06- 001

0

SHEET 6 of 6

	GREEN GAS LIMITED CITY GAS DISTRIBUTION PROJECT	
---	--	---

POLYETHYLENE PIPES FOR UNDERGROUND NETWORKS FOR NATURAL GAS DISTRIBUTION GENERAL REQUIREMENTS	CLIENT JOB NO.	
	TOTAL SHEETS	23

DOCUMENT NO	11	0326	02	07	02	001
--------------------	----	------	----	----	----	-----

--	--	--	--	--	--

0	30.12.11	ISSUED FOR TENDER	PD	SSJ	SB
A	16.11.11	ISSUED FOR CLIENT COMMENTS	PD	SSJ	SB
REV.	DATE	DESCRIPTION	PREP	CHKD	APPD

**Polyethylene pipes for underground networks for natural gas distribution
General requirements**

	POLYETHYLENE PIPES FOR UNDERGROUND NETWORKS FOR NATURAL GAS DISTRIBUTION GENERAL REQUIREMENTS	DOCUMENT NO.	REV
		11-0326-02-07-02-001	0
		SHEET 2 OF 23	

TABLE OF CONTENTS

1 SUBJECT AND AREA OF APPLICATION.....	4
2 REFERENCE STANDARDS AND SPECIFICATIONS	4
3 DEFINITIONS	5
4. MATERIAL SPECIFICATION.....	6
5 CHARACTERISTICS.....	7
6. TEST METHODS	11
7. MARKING	15
8. PACKAGING AND STORAGE	16
9. PRODUCT TYPE-APPROVAL.....	18
APPENDIX 1.....	20
APPENDIX 2.....	21
APPENDIX 3.....	22
APPENDIX 4.....	23



POLYETHYLENE PIPES FOR
UNDERGROUND NETWORKS FOR
NATURAL GAS DISTRIBUTION
GENERAL REQUIREMENTS

DOCUMENT NO.

REV

11-0326-02-07-02-001

0

SHEET 3 OF 23

1. SUBJECT AND AREA OF APPLICATION

This specification defines the requirements which must be met by polyethylene (PE) pipes used to construct underground networks for natural gas distribution.

This specification is based on draft standard prEN 1555-2, which states the options and defines supplementary requirements arising from specific provisions on safety and historic constraints relating to our networks.

Testing of the pipes is carried out in accordance with the procedures described in document 11-0326-02-07-02-003 "Polyethylene pipes for underground networks for natural gas distribution - Quality control of pipes".

2. REFERENCE STANDARDS AND SPECIFICATIONS

ISO 760: 1978	Determination of water - Karl Fisher method (General method)
ISO 4437: 1997	Buried polyethylene (PE) pipes for the supply of gaseous fuels- Metric series- Specifications
ISO 6259-3: 1997	Thermoplastics pipes - Determination of tensile properties-Part 3: Polyolefin pipes
ISO 3126: 1974	Plastic pipes- Measurement of dimensions
ISO 1183: 1987	Plastics - Methods for determining the density and relative density of non-cellular plastics
ISO/DIS 1183-3	Plastics - Methods for determining the density of non- cellular plastics - Part 3: Gas pyknometer method
ISO 2505-1: 1994	Thermoplastics pipes - Longitudinal reversion - Part 1: Determination methods
ISO 2505-2: 1994	Thermoplastics pipes - Longitudinal reversion - Part 2: Determination parameters
ISO 1167: 1996	Thermoplastics pipes for the conveyance of fluids- Resistance to internal pressure- Test method
EN 728:1997	Plastics piping and ducting systems - Polyolefin pipes and fittings - Determination of oxidation induction time.
EN 1056: 1996	Plastics piping and ducting systems - Plastics pipes and fittings - Method for exposure to direct (natural) weathering.
prEN 1555-1: 2001	Plastics piping systems for the supply of gaseous fuels- Polyethylene (PE)-Part 1: General.
prEN 1555-2: 2001	Plastics piping systems for the supply of gaseous fuels - Polyethylene (PE) - Part 2: Pipes.

	POLYETHYLENE PIPES FOR UNDERGROUND NETWORKS FOR NATURAL GAS DISTRIBUTION GENERAL REQUIREMENTS	DOCUMENT NO.	REV
		11-0326-02-07-02-001	0
		SHEET 4 OF 23	

EN ISO 12162: 1995 Thermoplastics materials for pipes and fittings for pressure applications- Classification and designation-Overall service (design) coefficient.

EN ISO 13479 Polyolefin pipes for the conveyance of fluids - Determination of resistance to crack propagation - Test method for slow crack growth on notched pipes (notch test).

ISO 4440-1: 1994 Thermoplastics pipes and fittings - Determination of melt mass-flow rate - Part 1: Test method.

ISO DIS 9080 Plastics piping and ducting systems - Determination of the long-term hydrostatic strength of thermoplastics materials in pipe form by extrapolation.

ISO 13477: 1997 Thermoplastics pipes for the conveyance of fluids - Determination of resistance to rapid crack propagation (RCP) - Small-scale-steady-state test (S4 test).

IS14885: 2001 Polyethylene pipes for the supply of Gaseous Fuels-Specifications.

11-0326-02-07-02-005 Polyethylene compounds for the manufacture of pipes and fittings for Underground natural gas distribution networks. Acceptance procedure.

3. DEFINITIONS

3.1. BATCH OF COMPOUND

By batch of compound, it means a homogeneous quantity of PE compound of the same origin and of a particular brand.

The batch must be registered under a single identification number (batch number) which leaves no doubt as to the origin, identity and date of manufacture of the compound.

3.2. BATCH OF PIPES

By batch of pipes, it means a homogenous lot of pipes with identical dimensions, made in a continuous process by the same extrusion machine and from the same batch of compound.

3.3. MINIMUM REQUIRED STRENGTH (MRS 10)

Standardised class of compounds for which the Lower Confidence Limit (LCL) is equal to 10.



POLYETHYLENE PIPES FOR
UNDERGROUND NETWORKS FOR
NATURAL GAS DISTRIBUTION
GENERAL REQUIREMENTS

DOCUMENT NO.

REV

11-0326-02-07-02-001

0

SHEET 5 OF 23

3.4. PE 100

Standard designation for PE compounds in class MRS 10.

For such PE compounds, the long-term hydrostatic strength — calculated and classified according to the standardised method (ISO 9080 and ISO 12162) for a temperature of 20°C, a period of 50 years and a reliability of 97.5 % — must be at least 10 MPa.

3.5 LOWER CONFIDENCE LIMIT (LCL)

A quantity with the dimensions of stress, in Megapascal, which can be considered as a property of the material under consideration and represents the 97.5% lower confidence limit of the predicted long-term hydrostatic strength at a temperature of 20°C for 50 years with internal water pressure.

3.6 Standard Dimensions Ratio (SDR)

SDR is the quotient of the nominal outside diameter and the nominal wall thickness (expressed rounded to one decimal)

$$\text{SDR} = d_e/e_n$$

d_e = nominal diameter of pipe

e_n = nominal thickness of pipe in mm

3.7 Overall Service (Design) Co-efficient (C)

C is an overall co-efficient with a value greater than 1 which takes into consideration service condition as well as properties of the components of a piping system other than those represented in the lower confidence limit. For this specification the minimum of C is 2.0

3.8 Maximum Allowable Operating Pressure (MAOP)

The highest effective pressure of the gas in the pipeline system expressed in bar, which is allowed in continuous use. It takes into account the physical and the mechanical characteristics of the components of the piping system.'

It is given by the equation:

$$\text{MAOP} = (20 \times \text{MRS}) / (C \times (\text{SDR} - 1))$$

4. MATERIAL SPECIFICATION

The PE compounds that are acceptable shall conform to the requirements for PE 100 described in prEN1555-1.

In order to be approved, materials shall conform with the WGI technical specification 11-0326-02-07-02-005 "Polyethylene compounds for manufacture of pipes and fittings for underground networks for natural gas distribution - Acceptance procedure."

	POLYETHYLENE PIPES FOR UNDERGROUND NETWORKS FOR NATURAL GAS DISTRIBUTION GENERAL REQUIREMENTS	DOCUMENT NO.	REV
		11-0326-02-07-02-001	0
		SHEET 6 OF 23	

Approved materials are listed in Appendix 1.

Characteristics of PE Compound are given in Appendix 3.

Following are forbidden:

- a. use of recycled materials;
- b. mixture of different materials;
- c. addition of complementary materials by the pipe manufacturer.

5. CHARACTERISTICS

5.1. RAW MATERIAL

All the characteristics of the PE Compound are in accordance with the provisions of prEN 1555-1 or IS 14855 for PE 100 materials and for the limit values listed in the table in Appendix 3.

5.2. PIPES

5.2.1. Physical characteristics

5.2.1.1. Appearance of pipes

The appearance of the pipes is checked in accordance with 6.1.

The pipes must be square cut with smooth trimmed ends.

The internal and external surfaces of the pipes, examined visually without magnification, are uniform and smooth.

The pipes are free of scratches, pits, voids, blisters, occlusions or cracks.

5.2.1.2. Colour

The pipes shall be orange in accordance with the local requirements.

	POLYETHYLENE PIPES FOR UNDERGROUND NETWORKS FOR NATURAL GAS DISTRIBUTION GENERAL REQUIREMENTS	DOCUMENT NO.	REV
		11-0326-02-07-02-001	0
		SHEET 7 OF 23	

5.2.1.3. Density

Density is measured in accordance with the provisions of § 6.2. The measured value must correspond to the data listed in the table in Appendix 3, allowing for possible differences caused by measuring on the pipe instead of granulate.

5.2.1.4. Melt mass-flow rate (MFR)

The melt mass-flow rate MFR (190°C - 5 kg), measured on a sample taken from the pipe in accordance with 6.3., is within the limits stated in the table in Appendix 3: characteristics of PE Compound.

In addition, the discrepancy in absolute value between the MFR measured on a pipe sample and that measured on a sample of raw material may not exceed 20% of the latter.

5.2.1.5. Volatile content

The volatile content, measured on a pipe sample in accordance with Clause 6.4., may not exceed 350 mg/kg.

5.2.1.6. Water content

The water content may be estimated by measuring the volatile content.

If the volatile content, measured in accordance with 6.4., is more than 250 mg/kg, the water content must be ascertained.

The water content, measured in accordance with 6.5., must be 250 mg/kg or less.

5.2.1.7. Thermal stability (OIT)

Thermal stability is measured in accordance with § 6.6 on samples taken from the wall at random.

The minimum oxidation induction time at 210°C is 20 minutes. The maximum admissible decrease in the oxidation induction time measured on a pipe sample compared to that measured on the raw material, may not exceed 20% of the latter.

5.2.1.8. Resistance to atmospheric influence

Resistance to atmospheric influence is tested in accordance with § 6.7.

	POLYETHYLENE PIPES FOR UNDERGROUND NETWORKS FOR NATURAL GAS DISTRIBUTION GENERAL REQUIREMENTS	DOCUMENT NO.	REV
		11-0326-02-07-02-001	0
		SHEET 8 OF 23	

The exposure dose corresponds to a total energy of at least 3.5 GJ/m².

After testing, the pipe sample must meet the specifications laid down in § 5.2.1.7 (thermal stability), 5.2.2.2 (resistance to internal hydraulic pressure) and 5.2.2.5 (stress at yield point and elongation to fracture). In the latter test, only elongation to fracture is taken into consideration.

5.2.2. Mechanical characteristics -

5.2.2.1. Internal stresses

Internal stresses are measured in accordance with § 6.8. The variation in length between the reference points must be 3% or less.

5.2.2.2. Resistance to internal hydraulic pressure

The tests are carried out in accordance with §6.9. The test specimens taken from a batch of pipes show no leakage in the conditions of temperature, wall stress and test length stated in the tables in Appendix 4: resistance to internal hydraulic pressure.

If, for a given material, during the test at 80°C - 165 hrs with the highest wall stress σ , fracture occurs before the specified time and is ductile in nature, the tests are repeated with a minimum time of 1,000 hrs and the corresponding wall stress level as specified in Appendix 4.

5.2.2.3. Resistance to slow cracking (Notch test)

The test is carried out on pipes with a nominal diameter ≥ 90 using the test method stated at 6.10. No fracture will occur on the samples for test periods of less than 500 hrs.

5.2.2.4. Resistance to growth of cleavage fractures

Pipes with a diameter ≥ 90 are tested in accordance with the test described at § 6.11. The critical pressure at 0°C is at least 3 bar.

5.2.2.5. Stress at yield point and elongation to fracture

The test is carried out as described at Cl 6.12.

	POLYETHYLENE PIPES FOR UNDERGROUND NETWORKS FOR NATURAL GAS DISTRIBUTION GENERAL REQUIREMENTS	DOCUMENT NO.	REV
		11-0326-02-07-02-001	0
		SHEET 9 OF 23	

The minimum stress at the yield point is defined in the table “Characteristics of PE Compound” (Appendix 3).

Elongation to fracture must be more than 350% for each test specimen.

5.2.3 Dimensional characteristics

The dimensions are measured in accordance with 6.13.

5.2.3.1. Series

The pipes belong to either series SDR 11 or 17.6 in table A below:

TABLE A

Nominal Diameter de	Thickness en (mm)	
	SDR 11	SDR 17.6
20	2.0	2.3
32	3.0	2.3
63	5.8	3.6
90	8.2	5.2
125	11.4	7.1

5.2.3.2. Length

The length of the pipes is specified in the order. The preferred lengths are defined in §8.2.

The tolerances for straight pipes are: - 0 / + 0.05 m

The tolerances for rolled pipes are: - 0 / + 0.50 m

5.2.3.3. Mean external diameter D_m

The extreme mean external diameters are stated in ISO 4437.



POLYETHYLENE PIPES FOR
UNDERGROUND NETWORKS FOR
NATURAL GAS DISTRIBUTION
GENERAL REQUIREMENTS

DOCUMENT NO.

11-0326-02-07-02-001

SHEET 10 OF 23

REV

0

5.2.3.4. External diameter D - ovalisation

The maximum deviation permitted in relation to nominal diameter d_e is given ISO 4437.
In the event of dispute regarding the dimensions of rolled pipes, the dimensions shall be reviewed 24 hours after the pipe has been unrolled.

5.2.3.5. Thickness

The thicknesses are given in table A and have been taken from ISO 4437.

5.2.4 Reversion Test

When tested as per Clause 6.14, the value of longitudinal reversion shall not be greater than 3%.

5.2.5 Tensile Test

When tested in accordance with Cl. 6.15 at $23 \pm 1^\circ\text{C}$ at a speed of 100 mm/min \pm 10% for specimen thickness below 5 mm and at a speed of 25 mm/min for thickness above 5mm, the value obtained shall be as follows:

Tensile yield strength	15 MPa, Min
Elongation at Break	350 %, Min

5.2.6 Squeeze off

On all sizes of pipe up to and including 400 mm diameter, strength after squeeze-off and subsequent rerounding, must be demonstrated by testing as per Cl. 6.16.

5.2.7 Pigment Dispersion

When tested as per Annex E of IS 14885, the grading should be ≤ 3 .

6.0 TEST METHODS

6.1. APPEARANCE

The pipes are presented on suitable work surfaces and examined visually.
A suitable artificial lighting system is used to examine their internal appearance.

6.2. DENSITY

The density is tested using the method described in ISO 1183, with the result expressed in kg/m^3 .

	POLYETHYLENE PIPES FOR UNDERGROUND NETWORKS FOR NATURAL GAS DISTRIBUTION GENERAL REQUIREMENTS	DOCUMENT NO.	REV
		11-0326-02-07-02-001	0
		SHEET 11 OF 23	

6.3. MELT MASS-FLOW RATE (MFR)

The melt mass-flow rate shall be ascertained in accordance with standard ISO 4440-1 or IS-14885.

6.4. DETERMINATION OF VOLATILE CONTENT

The volatile content is checked using the method described in ISO 4437/IS 14885.

6.5. DETERMINATION OF WATER CONTENT USING KARL FISCHER METHOD

The water content is measured using the Karl Fischer method described ISO 760.

6.6. THERMAL STABILITY (OIT)

The test is carried out in accordance with the minimum oxidation induction time (OIT) of the material from the product shall be ≥ 20 min when tested as per Annex. D of IS 14885.

6.7. RESISTANCE TO ATMOSPHERIC INFLUENCE

Resistance to atmospheric influence is tested in accordance with the specifications of standard EN 1056.

Artificial exposure is also acceptable, provided it can be proved that the test is equivalent to the natural exposure test.

6.8. INTERNAL STRESSES

Internal stresses are measured using the methods described in ISO 2505.

The test temperature is $110 \pm 2^\circ\text{C}$.

Table B states the time depending on the thickness of the pipe and the method used.

	POLYETHYLENE PIPES FOR UNDERGROUND NETWORKS FOR NATURAL GAS DISTRIBUTION GENERAL REQUIREMENTS	DOCUMENT NO.	REV
		11-0326-02-07-02-001	0
		SHEET 12 OF 23	

Table B

Wall Thickness mm	Time in minutes	
	Bath	Stove
e<8	15	60
8<=e<16	30	120
16<=e	60	240

6.9. RESISTANCE TO INTERNAL HYDRAULIC PRESSURE

The test method is that described in ISO 1167.

The test pressure is calculated using the following formula, based on the nominal diameters and thicknesses.

$$P = 10 \cdot \sigma(2 \cdot e_n) / (d_e - e_n)$$

where

σ = pipe wall stress in MPa

d_e = nominal diameter of pipe

e_n = nominal thickness of pipe in mm

p = test pressure in bar

In the event of dispute, the test pressure shall be calculated on the basis of the diameters and thicknesses measured.

The test specimens taken from a batch of pipes show no leakage in the conditions of temperature, wall stress and test length stated in the tables in Appendix 4: resistance to internal hydraulic pressure.

Fractures at 80°C must be of the cleavage type. The minimum fracture time is defined by the straight line at 80°C connecting the points specified in the tables in Appendix 4.

If the pressure and/or temperature limits specified are exceeded, this is noted in the report stating the reason and scale (times and limit values).

	POLYETHYLENE PIPES FOR UNDERGROUND NETWORKS FOR NATURAL GAS DISTRIBUTION GENERAL REQUIREMENTS	DOCUMENT NO.	REV
		11-0326-02-07-02-001	0
		SHEET 13 OF 23	

If during the minimum specified time the pressure and/or temperature have exceeded the upper limits determined by the standard, the test is taken into consideration if the cracking time is higher than the specified minimum. Otherwise, the test must be repeated.

On the other hand, the test must be repeated if the pressure and/or temperature fall below the lower limits.

6.10. RESISTANCE TO SLOW CRACKING (NOTCH TEST)

The test is carried out in accordance with EN ISO 13479 at 80°C on a notched pipe with a wall stress of 4.6 MPa.

6.11. RESISTANCE TO GROWTH OF CLEAVAGE FRACTURES

Resistance to the growth of cracks is tested using test S4 described in standard ISO 13477.

The test temperature is 0°C and the knife speed 20 m/sec.

6.12. STRESS AT YIELD POINT AND ELONGATION TO FRACTURE

The test is carried out in accordance with ISO 6529-3.

In the case of pipes with coextruded yellow lines, all test specimens must be taken such that the yellow marking axis coincides with the longitudinal axis of the test specimen.

For thicknesses of less than 12 mm, the test specimens shall be cut using a hollow punch.

The traction speed is 100 mm/min.

6.13. DIMENSIONS

All dimensions, except for lengths, are measured at a temperature of 23 ± 2°C using the methods described in ISO 3126.

6.14 Reversion Test

Shall be tested in according to the procedure given in Annex. C of IS 14885

6.15 Tensile Test

Shall be tested according to the procedure given in Annexure J of IS 14885.

	<p>POLYETHYLENE PIPES FOR UNDERGROUND NETWORKS FOR NATURAL GAS DISTRIBUTION GENERAL REQUIREMENTS</p>	<p>DOCUMENT NO.</p>	<p>REV</p>
		<p>11-0326-02-07-02-001</p>	<p>0</p>
		<p>SHEET 14 OF 23</p>	

6.16 Squeeze off

Shall be tested in accordance with Annexure G of IS 14885.

7. MARKING

The marking is repeated at least once per metre. This marking is done on two diametrically opposite generating lines. The empty space between two technical data is filled by alternate repetition of the word "GAS".

Marking must be indelible and visible in colour.

The stamping must not affect the quality of the pipe.

The minimum height of the characters must be:

- 3 mm for nominal diameters ≤ 63
- 5 mm for nominal diameters ≥ 110 .

The depth of the marking must be ≤ 0.1 mm in the case of pipes with a nominal diameter ≤ 110 and ≤ 0.2 mm in the case of pipes with larger diameters.

Marking of the pipes shall include, in the following order, on each generating line:

- the word "GAS";
- the nominal diameter and the thickness of the wall;
- the SDR series;
- the date of manufacture (year, month, day);
- the work team in Roman numerals;
- the commercial name or code of the resin used (see Appendix 2);
- the code of the extrusion machine;

	POLYETHYLENE PIPES FOR UNDERGROUND NETWORKS FOR NATURAL GAS DISTRIBUTION GENERAL REQUIREMENTS	DOCUMENT NO.	REV
		11-0326-02-07-02-001	0
		SHEET 15 OF 23	

- the name or style of the manufacturer.

Any other marking, either in terms of the application technique or the data specified, must be submitted to the Company for approval in advance.

8. PACKAGING AND STORAGE

8.1. GENERAL

The manufacturer shall take all necessary action to prevent the pipes from deteriorating during storage, loading and transport.

The pipes may be supplied in straight lengths or in rolls. Straight lengths are normally placed in crates.

The pipes are fitted with sealing devices at both ends, of a model approved by the Company.

8.2. LENGTHS

The preferred pipe lengths are given in table C below.

TABLE C

Nominal diameter de	Preferred Length in meters		
	Coils		Straight pipes
20	100		-
32	100		-
63	100		-
90	50		
125	50		-

The lengths to be supplied are specified in the order.

The lengths to be supplied are specified in the SOR order.

8.3. PACKAGING

8.3.1. Packaging of straight pipes

If the pipes are supplied in crates, these must correspond to the diagram in Appendix 5.



POLYETHYLENE PIPES FOR
UNDERGROUND NETWORKS FOR
NATURAL GAS DISTRIBUTION
GENERAL REQUIREMENTS

DOCUMENT NO.

11-0326-02-07-02-001

SHEET 16 OF 23

REV

0

The wooden framework is banded using galvanized steel hoops. The tension of the hoops is such that the pieces of wood forming the framework are in contact with one another and the overlap of the crosspieces on the uprights is 2/3 the thickness of the latter.

8.3.2. Packaging of rolled pipes

Each roll includes an adequate number of hoops made from cords or bands of synthetic material, evenly distributed around the whole circumference of the bundle. In each case there must be a hoop less than 0.3 m from each end of the pipes.

The packaging must on no account adulterate the pipe.

8.4. HANDLING AND STORAGE

Immediately after production, pipes shall be handled with great care from the production line to the storage place, in order to avoid any damage such as scratches, notches, superficial wear and tear, holes, dented walls or similar.

If handled by forklift or similar equipment, the metallic forks shall be covered with a soft material in order to avoid any damage to the pipes.

The extremities of the pipes shall not be in contact with the floor while handling.

Indoor storage is preferred.

Outdoor storage is permitted at the following conditions:

- Storage periods are not exceeding one month
- Pipes are protected from direct sunlight by a suitable shelter
- Pipes are stored on a hard storage surface clean from excessive dust, stones, water etc.
- Pipes are not in contact with the soil, but are supported by soft material such a wood etc.
- Pipes are protected from damages caused by traffic of forklifts, trucks etc.

8.5 SEALS

	POLYETHYLENE PIPES FOR UNDERGROUND NETWORKS FOR NATURAL GAS DISTRIBUTION GENERAL REQUIREMENTS	DOCUMENT NO.	REV
		11-0326-02-07-02-001	0
		SHEET 17 OF 23	

Prior to execution of the order, the manufacturer must submit to the Company the seals which it intends to use for all the types of pipes ordered.

The seals shall preferably be made of PE or a material which does not adulterate polyethylene. Metal and PVC seals are not permitted. The seals must be able to withstand storage times as guaranteed in § 8.6. of this specification, and also to withstand handling during installation.

They must not be brittle or sharp and the materials, shapes and dimensions thereof must be such that they cannot fully penetrate inside the pipes.

They are of the internal plug type for all pipes supplied in straight lengths, and for pipes rolled in coils or on reels, the seals may be caps.

All seals are fitted with a valve to prevent pressurization or depressurizations of the pipes, depending on climatologically temperature cycles.

In theory, they are placed on the pipes immediately after completion of the manufacturing tests, but before storage of the pipes. In the event of acceptance, the pipe plugs are removed and replaced by the supplier.

The seals cannot be recycled after the pipes have been installed. Their removal on site should not require the use of special tools.

8.5. STORAGE WARRANTY

It must be possible to store the pipes in the open air, protected from direct sunlight, without taking any other special precautions for at least two years from the date of manufacture stated on the pipe.

The storage warranty covers continued conformity of the dimensions, characteristics and performances laid down in this specification.

8.6. DEADLINE FOR SUPPLY

The pipes must be supplied to the user within one month following the date of manufacture.

9. PRODUCT TYPE-APPROVAL

For the purposes of type-approval of the product, the manufacturer is obliged to supply a technical file as defined in WGI procedure 11-0326-02-07-02-007

Type-approval of the products is carried out in accordance with the aforementioned procedure.

	<p>POLYETHYLENE PIPES FOR UNDERGROUND NETWORKS FOR NATURAL GAS DISTRIBUTION GENERAL REQUIREMENTS</p>	<p>DOCUMENT NO.</p>	<p>REV</p>
		<p>11-0326-02-07-02-001</p>	<p>0</p>
		<p>SHEET 18 OF 23</p>	

Any change to the type-approved product, process or manufacturing equipment must be notified to the Company in writing.

Any failure in this respect shall incur withdrawal of type-approval until termination of the contract.

	POLYETHYLENE PIPES FOR UNDERGROUND NETWORKS FOR NATURAL GAS DISTRIBUTION GENERAL REQUIREMENTS	DOCUMENT NO.	REV
		11-0326-02-07-02-001	0
		SHEET 19 OF 23	

APPENDIX 1

Approved materials

The materials which have passed the “WGI” approval procedure for PE materials(“ 11-0326-02-07-02-007”) are approved for manufacture of the pipes.

For information, the following materials have been approved to date:

Solvay Eltex TUB 121 (black)	PE 100
or Eltex TUB 125 (orange)	
Borealis HE 2490	PE 100
Fina Finathene XS 10 B	PE 100
Dow BG 10050	PE 100
Elenac Hostalen CRP 100	PE 100

	POLYETHYLENE PIPES FOR UNDERGROUND NETWORKS FOR NATURAL GAS DISTRIBUTION GENERAL REQUIREMENTS	DOCUMENT NO.	REV
		11-0326-02-07-02-001	0
		SHEET 20 OF 23	

APPENDIX 2

Code for different raw materials

Manufacturer	Commercial brand name		Code (*)
SOLVAY	ELTEX	TUB 121/125	E3
BOREALIS		HE 2490	N3
FINA	FINATHENE	XS 10 B	F3
DOW		BG10050	D1
ELENAC	HOSTALEN	CRP100	H7

*Based on the GERG List



POLYETHYLENE PIPES FOR
UNDERGROUND NETWORKS FOR
NATURAL GAS DISTRIBUTION
GENERAL REQUIREMENTS

DOCUMENT NO.

REV

11-0326-02-07-02-001

0

SHEET 21 OF 23

APPENDIX 3

Characteristics of PE Compound

Characteristics	Units	Requirements	Test Parameters	Test Method
Conventional density	kg/m ³	>=928.4(base Polymer) >=928.4(base Polymer)	23 ⁰ C 27 ⁰ C	IS 7328:1992 ¹⁾
Melt flow rate	g/10 min	+/- 20 % of value nominated by compound producer	190 ⁰ C /5.0 Kg	IS 2530:1963
Thermal Stability	min	>= 20	200 ⁰ C	Annex D of IS 14855
Resistance to gas Constituents	h	>= 20	80 ⁰ C	Clause 5.5
Pigment Dispersion	Grade	<= 3		Annex E of IS 14855

1) See Explanatory Notes at Annex L

NOTE — Indian testing methods mentioned in IS 7328 and IS 2530 for the determination of conventional density and mass flow rate have been found co-related with ISO/British Standard Testing methods, such as ISO 1183-1983(E), ISO 1133-1991(E), ISO 6964 and BS 2782 Part 8, method 823-A, 823-B, 1978 respectively. The compound shall confirm to the weathering requirements for thermal stability as above, hydrostatic strength HS (165 h-80°C) at induced stress 4.6 MPa and 5.5 MPa for PE-80 and PE-100 material respectively and elongation at break 350 percent minimum after exposure of the test as per Annex F.



POLYETHYLENE PIPES FOR
UNDERGROUND NETWORKS FOR
NATURAL GAS DISTRIBUTION
GENERAL REQUIREMENTS

DOCUMENT NO.

REV

11-0326-02-07-02-001

0

SHEET 22 OF 23

APPENDIX 4

Resistance to internal hydraulic pressure

Specification of test parameters

PE 100 materials (MRS10)

Test type	Minimum Time hours	Type of fracture
20°C- $\sigma \geq 12.4$ MPa	100	ductile
40°C- $\sigma \geq 5.5$ MPa	165	cleavage
80°C- $\sigma \geq 5.0$ MPa	1000	-

If a ductile fracture occurs during the test at 80°C - 165 hrs, the test is repeated for 1,000 hrs at a lower stress level.



POLYETHYLENE PIPES FOR
UNDERGROUND NETWORKS FOR
NATURAL GAS DISTRIBUTION
GENERAL REQUIREMENTS

DOCUMENT NO.

REV

11-0326-02-07-02-001

0

SHEET 23 OF 23



**GREEN GAS LIMITED
CITY GAS DISTRIBUTION PROJECT**



POLYETHYLENE PIPES FOR UNDERGROUND NETWORKS FOR NATURAL GAS DISTRIBUTION - TECHNICAL DATASHEET				CLIENT JOB NO.		
				TOTAL SHEETS		05
DOCUMENT NO	11	0326	02	07	02	002

--	--	--	--	--	--	--

REV.	DATE	DESCRIPTION	PREP	CHKD	APPD
0	30.12.11	ISSUED FOR TENDER	PD	SSJ	SB
A	16.11.11	ISSUED FOR CLIENT COMMENTS	PD	SSJ	SB

Polyethylene pipes for underground networks for natural gas distribution
Technical Datasheet



POLYETHYLENE PIPES FOR
UNDERGROUND NETWORKS FOR
NATURAL GAS DISTRIBUTION
TECHNICAL DATASHEET

DOCUMENT NO.

REV

11-0326-02-07-02-002

0

SHEET 2 OF 5

TABLE OF CONTENTS

1.0 REFERENCE DOCUMENTS.....4

	POLYETHYLENE PIPES FOR UNDERGROUND NETWORKS FOR NATURAL GAS DISTRIBUTION TECHNICAL DATASHEET	DOCUMENT NO.	REV
		11-0326-02-07-02-002	0
		SHEET 3 OF 5	

1.0 REFERENCE AND STANDARD DOCUMENTS

- 11-0241-02-07-02-001 Polyethylene pipes for underground networks for natural gas distribution - General requirements.
- 11-0241-02-07-02-003 Polyethylene pipes for underground networks for natural gas distribution -Quality control of pipes.
- 11-0241-02-07-02-007 Supplementary procedure for type-approval of polyethylene pipes for underground networks for natural gas distribution.
- IS 14885 Polyethylene Pipes for the Supply of Gaseous Fuels-Specification

DN	en	SDR	Coil Length in metres	Total Length (M)	Approved Material	Weight/m (Kg/m)
20	2	11	100	36000	E3-N3-F3-D1-H3	0.162
32	3	11	100	97350	E3-N3-F3-D1-H3	0.28
63	5.8	11	100	23700	E3-N3-F3-D1-H3	1.05
90	8.2	11	50	7700	E3-N3-F3-D1-H3	1.39
125	11.4	11	50	7500	E3-N3-F3-D1-H3	4.1

(*) approximative value according to DIN 8074

	POLYETHYLENE PIPES FOR UNDERGROUND NETWORKS FOR NATURAL GAS DISTRIBUTION TECHNICAL DATASHEET	DOCUMENT NO.	REV
		11-0326-02-07-02-002	0
	SHEET 4 OF 5		

Manufacturer	Commercial brand name		Code (*)
SOLVAY	ELTEX	TUB 121/125	E3
BOREALIS	HE 2490		N3
FINA	FINATHENE	XS10B	F3
DOW	BG1005O		DI
ELENAC	HOSTALEN	CRP 100	H7



POLYETHYLENE PIPES FOR
UNDERGROUND NETWORKS FOR
NATURAL GAS DISTRIBUTION
TECHNICAL DATASHEET



DOCUMENT NO.

REV

11-0326-02-07-02-002

0

SHEET 5 OF 5

	GREEN GAS LIMITED CITY GAS DISTRIBUTION PROJECT	
---	--	---

POLYETHYLENE PIPES FOR UNDERGROUND NETWORKS FOR NATURAL GAS DISTRIBUTION - QUALITY CONTROL OF PIPES					CLIENT JOB NO.		
DOCUMENT NO	11	0326	02	07	02	003	

--	--	--	--	--	--

0	30.12.11	ISSUED FOR TENDER	PD	SSJ	SB
A	16.11.11	ISSUED FOR CLIENT COMMENTS	PD	SSJ	SB
REV	DATE	DESCRIPTION	PREP	CHK	APPR

POLYETHYLENE PIPES FOR UNDERGROUND NETWORKS FOR NATURAL GAS
DISTRIBUTION QUALITY CONTROL OF PIPES



POLYETHYLENE PIPES FOR
UNDERGROUND NETWORKS FOR
NATURAL GAS DISTRIBUTION
QUALITY CONTROL OF PIPES

DOCUMENT NO.

Rev

11-0326-02-07-02-003

0

Page 2 of 19

TABLE OF CONTENTS

1.	SUBJECT AND AREA OF APPLICATION	4
2.	REFERENCE AND STANDARD DOCUMENTS	4
3.	GENERAL PRINCIPLES.....	4
4.	TESTS.....	4
	APPENDIX 1 – TABLES OF SAMPLES	9
	APPENDIX 2- DIMENSIONAL REQUIREMENTS	11
	APPENDIX 3- FACTORY CERTIFICATE.....	12
	APPENDIX 4- STOCK LIST.....	13
	APPENDIX 5- ASSESSMENT OF APPEARANCE DEFECTS ON INTERNAL AND EXTERNAL SURFACES OF POLYETHYLENE PIPES FOR UNDERGROUND.....	15
1	PREAMBLE	15
2.	DESCRIPTION OF MAIN APPEARANCE DEFECTS.....	15
3.	ASSESSMENT CRITERIA.....	17
4.	ACCEPTANCE CRITERIA FOR BATCHES	18

	POLYETHYLENE PIPES FOR UNDERGROUND NETWORKS FOR NATURAL GAS DISTRIBUTION QUALITY CONTROL OF PIPES	DOCUMENT NO.	Rev
		11-0326-02-07-02-003	0
		Page 3 of 19	

1. SUBJECT AND AREA OF APPLICATION

The purpose of this document is to define the test requirements to be met by PE pipes in accordance with the latest version of the WGI specification listed on reference documents 11-0326-02-07-02-001, -002, -007

2. REFERENCE AND STANDARD DOCUMENTS

11-0326-02-07-02-001	Polyethylene pipes for underground networks for natural gas distribution - General requirements.
11-0326-02-07-02-002	Polyethylene pipes for underground networks for natural gas distribution -Technical data sheet.
11-0326-02-07-02-007	Supplementary procedure for type-approval of polyethylene pipes for underground networks for natural gas distribution.
IS 14885	Polyethylene Pipes for the Supply of Gaseous Fuels-Specification

3. GENERAL PRINCIPLES

3.1. MANUFACTURER'S RESPONSIBILITY

The manufacturer is totally responsible for the quality of the pipes which he manufactures. Acceptance Test procedures do not absolve him from this responsibility.

In order to ensure that the pipes comply with the specification in every case, tie pipes are tested by the factory control department, which is separate from its production department.

The pipes supplied are guaranteed for one year after commissioning or three years maximum after the date of manufacture.

3.2. QUALITY ASSURANCE

The manufacturer must have a quality assurance system in place as described in standard EN 29001 or EN 29002. The quality manual must be supplied to the Owner/ owner representative Quality Control Department.

The quality assurance system shall be certified by an accredited body.

3.3. SPECIMEN SAMPLE OF GRANULATE

The manufacturer shall supply the Owner/ owner representative Quality Control Department with a kilo of granulate from each batch of material used to manufacture the pipes.

The specimen sample is taken in the presence of the Owner/ owner representative Quality Control Department official if testing takes place during manufacture. A suitable container shall be supplied to the manufacturer by Owner.

All necessary precautions shall be taken to prevent contamination and deterioration of the granulate during sampling and during subsequent handling of the sample.

4. TESTS

4.1. TESTS CARRIED OUT BY THE MANUFACTURER

	POLYETHYLENE PIPES FOR UNDERGROUND NETWORKS FOR NATURAL GAS DISTRIBUTION QUALITY CONTROL OF PIPES	DOCUMENT NO.	Rev
		11-0326-02-07-02-003	0
		Page 4 of 19	

4.1.1. General

It is essential to comply with the provisions in the following sections to ensure that the pipes conform to the specification in every case.

All the pipes are individually numbered. This marking is done using an inert product which will not adulterate the quality of the pipes (e.g. lithographic chalk). The pipe number consists of a maximum of three digits. In the case of pipes with a diameter of 90 mm or more, the number is marked on the inside. For rolled pipes and pipes on drums, it is applied on an adjoining label and the marking must not be subject to deterioration.

4.1.2. Individual tests

4.1.2.1. Appearance

The external and internal appearance of each pipe is checked in accordance with the document, "Assessment of appearance defects on the internal and external surfaces of polyethylene pipes for underground networks for natural gas distribution" (see Appendix 5). A suitable artificial lighting system is used to check the internal appearance.

4.1.2.2. Dimensions

The thickness and average diameter (see Appendix 2), measured in the conditions defined in the specification, are entered in an inspection document which includes the dates of manufacture and the production team, extruder number, code of the material used, pipe number and, if a pipe is declared invalid, the reason for the rejection.

When the manufacturer carries out continuous measurement of the thickness, the record of the values measured shall include all the details necessary for marking of the pipes.

The, inspection documents and any records shall be supplied to the Owner/ owner representative official.

4.1.3. Each batch of material

The pipe manufacturer shall ask the raw material manufacturer for a certificate showing:

- melt mass-flow rate;
- water content;
- density;
- carbon black content;
- carbon black quality;
- thermal stability.

The pipe manufacturer shall carry out the following checks and tests on each batch of material:

- melt mass-flow rate on resin before use;
- volatile and water content;
- thermal stability of the resin.

	POLYETHYLENE PIPES FOR UNDERGROUND NETWORKS FOR NATURAL GAS DISTRIBUTION QUALITY CONTROL OF PIPES	DOCUMENT NO.	Rev
		11-0326-02-07-02-003	0
		Page 5 of 19	

These checks and tests shall be carried out in the conditions laid down in technical specification 11-0326-02-07-02-001

The results are entered in documents showing full identification of the batch of pipe, to be supplied to the Owner/ owner representative official.

4.1.4. Each batch of pipes

For each batch of pipes, the manufacturer shall carry out the following checks and tests in addition to the above-mentioned individual tests:

- ovalisation;
- length;
- melt mass-flow rate on pipe;
- thermal stability of pipe;
- internal stresses;
- resistance to internal hydraulic pressure at 20°C and 80°C;
- determination of traction characteristics of pipes; tension at yield point at 23°C and elongation to fracture at 23°C;
- end-to-end weldability for pipes with diameters of 110 mm or more.

These checks and tests are carried out in the conditions defined in technical specification 11-0326-02-07-02-001

The results are entered in documents showing full identification of the batch of pipes and supplied to Owner/ owner representative.

4.1.5. Type-approval of pipes

When a new material aid/or a new extruder is used, the manufacturer must have the product type-approved in accordance with the 11-0326-02-07-02-007 type-approval procedure.

4.1.6. Special tests

- Resistance to atmospheric influence.
- Resistance to growth of cleavage fractures.
- Resistance to slow cracking (notch test).

If necessary, these tests shall be carried out by mutual agreement in an independent laboratory.

4.2 FACTORY ACCEPTANCE BY OWNER/ OWNER REPRESENTATIVE QUALITY CONTROL DEPARTMENT OFFICIAL

4.2.1. General

Acceptance tests may have to be carried out in the presence of an official from the Owner/ owner representative Quality Control Department.

	POLYETHYLENE PIPES FOR UNDERGROUND NETWORKS FOR NATURAL GAS DISTRIBUTION QUALITY CONTROL OF PIPES	DOCUMENT NO.	Rev
		11-0326-02-07-02-003	0
		Page 6 of 19	

All checks and tests are carried out in the conditions laid down in technical specification 11-0326-02-07-02-001

The results must be in accordance with the provisions specified therein and with the individual specifications of the order.

On each visit, the manufacturer provides the Owner/Owner's representative free of charge with the facilities and personnel necessary to carry out the tests laid down in the specification. In addition, during execution of the order, the Owner/Owner's representative has access to the storage installations for the raw materials before manufacture, the manufacturing and testing installations and the storage areas for the pipes for which Owner/Owner's representative is responsible for testing.

On arrival at the factory for his inspection, Owner/Owner's representative receives a certificate for each batch of pipes presented for acceptance. This document shall be consistent with the specimen in Appendix 3.

In addition, when acceptance relates to part of an order, the supplier must provide the Owner/Owner's representative with a stock list and a history of the stock of pipes intended for CONSULTANT. A specimen of this form is attached to this document: Appendix 4.

Whenever so requested by the Owner/Owner's representative, the manufacturer must be able to provide him with recent test and calibration reports for the measuring instruments and test installations.

4.2.2. Convening notice for acceptance

The acceptance convening procedures are specified in the order.

4.2.3. Acceptance tests

4.3.2.1. Appearance, dimensions and marking

The number of pipes examined is at least 10 % of the pipes presented for acceptance.

The pipes to be examined are placed on work trestles or grids for ease of testing.

Rolled pipes are presented on reels.

4.2.3.2. Checking of characteristics

For each batch of pipes as defined in technical specification 11-0241-02-07-02-001 or a constituent part thereof, the minimum samples to be taken are stated in the table in Appendix 1.

4.3 ACCEPTANCE AND REJECTION

4.3.1. Appearance, dimensions and marking

Any failure means that the batch is rejected. It may however be presented again after sorting, with the agreement of the Owner/Owner's Consultant.

4.3.2 Checking of characteristics

Any result which is not in accordance with the provisions of the specification and the individual specifications of the order shall give rise to a repeat test on at least double the number of samples. If the unfavorable result is confirmed, the batch is definitively rejected. If the unfavorable result is invalidated, the batch is accepted.

	POLYETHYLENE PIPES FOR UNDERGROUND NETWORKS FOR NATURAL GAS DISTRIBUTION QUALITY CONTROL OF PIPES	DOCUMENT NO.	Rev
		11-0326-02-07-02-003	0
		Page 7 of 19	

By way of additional investigation, other analyses or examinations may be carried out by mutual agreement, at the manufacturer's expense.

4.4 DISPATCH WITHOUT ACCEPTANCE

If Owner/Owner's representative decides to waive the acceptance procedures, it reserves the right to ask the manufacturer to carry out the acceptance tests and checks laid down in 4.2.3.

The supplier is obliged to send the Owner/Owner's representative a factory certificate, the stock lists and the acceptance test and check report if these have been requested.

These documents shall contain the order references.

Failure to observe the above procedures shall be sanctioned by refusal to take delivery.

	POLYETHYLENE PIPES FOR UNDERGROUND NETWORKS FOR NATURAL GAS DISTRIBUTION QUALITY CONTROL OF PIPES	DOCUMENT NO.	Rev
		11-0326-02-07-02-003	0
		Page 8 of 19	

APPENDIX 1 – TABLES OF SAMPLES

Test	Quality criterion as per specification G001-1	Test method As per Specifications G001-1	No of samples per batch	Number of test specimens
Internal stresses	§ 5.2.2.1	§ 6.8	2	3 from the same pipe
Determination of traction characteristics	§ 5.2.2.5	§ 6.12	2	3 from the same pipe
Melt mass flow rate	§ 5.2.1.4	§ 6.3	2	1 from Same pipe
Resistance to internal hydraulic Pressure -at 20 ⁰ C	§ 5.2.2.2	§ 6.9	1	2 test specimen(+2 reserves)(1) 1 test specimen per pipe
-at 80 ⁰ C			1	2 test specimen(+2 reserves)(1) 1 test specimen per pipe
Weldability	§ 5.2.2.6	§ 6.13	2(4)	2 section of different pipe welded end to end
Traction on welded pipe	§ 5.2.2.2	§ 6.9	1	1 welded sample(3)
Resistance to internal hydraulic pressure -at 20 ⁰ C			1	See note (2)
-at 80 ⁰ C			1	See note (2)
Resistance to slow cracking of notched pipe (Notch test)			§ 5.2.2.3.	§ 6.10



POLYETHYLENE PIPES FOR UNDERGROUND NETWORKS FOR NATURAL GAS DISTRIBUTION
QUALITY CONTROL OF PIPES

DOCUMENT NO.

11-0326-02-07-02-003

Rev

0

Page 9 of 19

Resistance to growth of cleavage fractures	§ 5.2.2.4.	§ 6.11	4(3)	See note (5)	
Thermal stability of PE	§ 5.2.1.7.	§ 6.6	1(3)	See note (5)	

Notes

- (1) Number of test specimens to be tested: 1 specimen at start of manufacture and 1 specimen at end of manufacture per shift basis.
- (2) In agreement with the Owner official, these tests on welded test specimens may be included in the series of tests designed to check resistance to internal hydraulic pressure.
- (3) Performance of this test is left to the discretion of the Owner/Owner's Representative.
- (4) The number of welded samples per batch may be increased to three if the Owner official has decided to carry out the traction test on the welded sample.
- (5) The taking of samples is left to the discretion of the Owner official, if the manufacturer is not equipped to carry out these tests properly, they shall be carried out at the manufacturer's expense in a reputed laboratory chosen by Owner.

	POLYETHYLENE PIPES FOR UNDERGROUND NETWORKS FOR NATURAL GAS DISTRIBUTION QUALITY CONTROL OF PIPES	DOCUMENT NO.	Rev
		11-0326-02-07-02-003	0
		Page 10 of 19	

APPENDIX 2- DIMENSIONAL REQUIREMENTS

The pipes belong to either series SDR 11 or SDR 17.6 defined below:

THICKNESS

Nominal Diameter de	SDR 11			SDR17.6		
	en	emin in mm	emax in mm	en	emin in mm	emax in mm
20	3	3	3.4	-	-	-
32	3	3	3.5	-	-	-
63	5.8	5.8	6.6	-	-	-
90	8.2	8.2	9.2	-	-	-

MEAN EXTERNAL DIMENSIONS

Nominal Diameter de	MEAN EXTERNAL DIAMETER dm	
	dm min. in mm	dm max in mm
20	20	
32	32	32.3
63	63	63.4
90	90	



POLYETHYLENE PIPES FOR
UNDERGROUND NETWORKS FOR
NATURAL GAS DISTRIBUTION
QUALITY CONTROL OF PIPES

DOCUMENT NO.

11-0326-02-07-02-003

Rev

0

Page 11 of 19

APPENDIX 3 - FACTORY CERTIFICATE

PE pipes for underground gas networks		FACTORY CERTIFICATE n°	
Supplier:		Order :	
Dimensions:		SDR Series:	
Material:		Batch no:	
MRS:		Date of manufacture:	
1. TEST ON MATERIAL			
1.1 MFI :		g/10 min	
1.2 Volatile content :		mg/kg	
1.3 Thermal stability :		min	
2. PRODUCTION TEST ON EXTRUDED PIPES			
2.1 Dimensions	d _m min:	d min:	e _m min:
	d _m max:	d max:	e _m max:
2.2 Surface appearance	Smooth pipes free of cavities, pitting, scratches or other defects:		Checked:
2.3 Traction:	Elongation to fracture:		
2.4 Internal stresses:			
2.5 Weldability:			
2.6 Hydraulic tests:	80 °C - σ: N/mm ² :	20 °C - σ: N/mm ² :	hr
2.7 MFI:	g/10 min		
2.8 Thermal stability:	min		
2.9 Volatile content:	mg/kg		
3. Marking of pipes			
4.	Packing	Number	Unit length
	Crates		
	Rolls		
	Drums		
Date		Factory stamp	Signature



POLYETHYLENE PIPES FOR UNDERGROUND NETWORKS FOR NATURAL GAS DISTRIBUTION
 QUALITY CONTROL OF PIPES

DOCUMENT NO.

11-0326-02-07-02-003

Rev

0

Page 12 of 19

APPENDIX 4 - STOCK LIST

Stock list		PE pipes for natural gas distribution networks STS G001-3						Sheet n°		
Order n°		Acceptance/Authorisation (1) dated:						Material:		
		Ø = 32		Ø = 40		Ø = 63		R = Rolls		
		R 50 m	L 6 m	R 50 m	L 6 m	R 50 m	L 6 m	L = Straight length		
		SDR 11		SDR 11		SDR 11				
A	Stock available after acceptance n°								dated	
B	Deliveries								Call no.	Destination
1										
2										
3										
4										
5										
6										
7										
8										
C	Available before acceptance (A - Σ B)									
	Presented for acceptance									
D	Accepted									
E	Stock after acceptance (C + D)									
F	Balance on calls recorded								Call no.	Destination
1										
2										
3										
4										
5										
6										
7										
8										
9										
10										
G	Available (E - Σ F)								Comments:	
H	Stock not accepted									
I	In production									
	Stock still available to cover 1 month's consumption (G + H + I)									
Date:				Factory stamp						
Name:										
Signature:										

(1) delete as applicable

	POLYETHYLENE PIPES FOR UNDERGROUND NETWORKS FOR NATURAL GAS DISTRIBUTION QUALITY CONTROL OF PIPES	DOCUMENT NO.	Rev
		11-0326-02-07-02-003	0
		Page 13 of 19	

Stock list		PE pipes for natural gas distribution networks- STS G001-3				Sheet n°	
Order n°		Acceptance/Authorisation (1) dated:				Material:	
m	Ø = 110		Ø = 160	Ø = 200	Ø =	R = Rolls L = Straight length	
	R450	L14	L14	L14			
SDR	17,6	17,6	17,6	17,6			
A	Stock available after acceptance n° dated						
B	Deliveries					Call no.	Destination
1							
2							
3							
4							
5							
6							
7							
8							
9							
10							
C	Available before acceptance (A - Σ B)						
	Presented for acceptance						
D	Accepted						
E	Stock after acceptance (C + D)						

F	Balance on calls recorded				Call no.	Destination
1						
2						
3						
4						
5						
6						
7						
8						
9						
10						
G	Available (E - Σ F)				Comments:	
H	Stock not accepted					
I	In production					
	Stock still available to cover 1 month's consumption (G + H + I)					
Date:				Factory stamp		
Name:						
Signature:						

(1) Delete as applicable

	POLYETHYLENE PIPES FOR UNDERGROUND NETWORKS FOR NATURAL GAS DISTRIBUTION QUALITY CONTROL OF PIPES	DOCUMENT NO.	Rev
		11-0326-02-07-02-003	0
		Page 14 of 19	

APPENDIX 5- ASSESSMENT OF APPEARANCE DEFECTS ON INTERNAL AND EXTERNAL SURFACES OF POLYETHYLENE PIPES FOR UNDERGROUND NETWORKS FOR NATURAL GAS DISTRIBUTION

1 PREAMBLE

The internal and external surfaces of the tubes are examined visually with the naked eye, without magnification and under adequate lighting.

2. DESCRIPTION OF MAIN APPEARANCE DEFECTS

2.1. DEFECTS CAUSED BY HANDLING OR STORAGE

2.1.1. Incrustation with foreign matter

Pebbles, sand, glass, filings, wood splinters, etc..

2.1.2 Scratches

Narrow continuous lesions.

2.1.3 Notches

Incisions made by a sharp instrument.

2.1.4 Superficial wear and tear

Surface deterioration resulting from friction against foreign matter.

2.1.5 Holes

Holes in the wall caused by forceful insertion of a generally pointed object (e.g.: nails, probes, screws, etc.).

2.1.6 Dented walls

Permanent distortion of the wall accidentally caused during handling.

2.2 MANUFACTURING DEFECTS¹

2.2.1. Continuous longitudinal internal lines

Longitudinal marks evenly distributed around the inner circumference of the pipe, caused by fusion of material faces on exit from the extrusion tool. These marks are caused by an incorrect choice of transformation parameters.

2.2.2. Continuous longitudinal lines inside and outside

These do not exceed 0.20 mm in depth.

- They may be caused by the defective condition of the calibrators or the sealing device for the calibration system, in which case they are isolated instances.

- They may be caused by friction of residual deposits attached to parts of the extrusion tool, the calibrators or the sealing plug of the calibration system. In this case, they are generally randomly distributed.

	POLYETHYLENE PIPES FOR UNDERGROUND NETWORKS FOR NATURAL GAS DISTRIBUTION QUALITY CONTROL OF PIPES	DOCUMENT NO.	Rev
		11-0326-02-07-02-003	0
		Page 15 of 19	

These deposits may consist of waxes, oxidised polyethylene or other products which are released during transformation of the material in the extruder or which are present in the cooling water.

2.2.3. Incrustation with residual matter generated during extrusion

The deposits defined in 2.2.2. work loose and are crushed in the external wall of the pipes while passing into the calibrator, or adhere to the internal wall of the pipes.

2.2.4. Presence of foreign matter in the polyethylene resulting from contamination of the raw material .

This contamination may be caused by all sorts of liquid or solid products (oil, paper, cardboard, plastics, glass, sand, dust, etc.).

2.2.5. Excessive water and volatile contents

2.2.5.1. Porosity

Defects generally caused by volatile matter which occur specifically when the water and volatile contents are too high.

¹The term extrusion defect covers all defects resulting from the complete pipe manufacturing process.

2.2.5.2. Craters (surface spalling)

Shallow or deep conical cavities the cause of which is difficult to establish, generally the result of water and volatile contents being too high.

2.2.6 Pitting

Defects in the shape of aligned dots, either in clusters or dispersed, which are often connected with carbon black anomalies.

2.2.7 Unfused parts

Molecular polyethylene elements which are totally or partially unfused and located both on the surface and right inside the thickness of the pipe wall.

2.2.8 Cavities

Superficial denting of the external wall, sometimes replicated on the internal wall.

This is the result of distortion caused by a drop of water between the pipe and the calibrator at the intake. The water comes from the calibrator cooling system and is a common phenomenon if the pressure of the calibrator cooling water is too high.

2.3. DEFECTS CAUSED BY MARKING

2.3.1 Marking too deep

This is caused by incorrect setting of the stamps or the stamp design.

2.3.2 Indentations caused by the tool holding the marking stamps

These are the result of incorrect settings or wear and tear.

	POLYETHYLENE PIPES FOR UNDERGROUND NETWORKS FOR NATURAL GAS DISTRIBUTION QUALITY CONTROL OF PIPES	DOCUMENT NO.	Rev
		11-0326-02-07-02-003	0
		Page 16 of 19	

3. ASSESSMENT CRITERIA

3.1. CRITICAL DEFECTS

The following defects are critical:

- Continuous longitudinal internal lines (see § 2.2.1.)
- Presence of foreign matter in the polyethylene resulting from contamination of the raw material (see § 2.2.4.)
- Porosity (see § 2.2.5.1.)

3.2 OTHER DEFECTS

Defects caused by handling or storage

Pipes presenting one of the following defects are classified as defective:

- Incrustation with foreign matter (see § 2.1.1.).
- Scratches (see § 2.1.2.), the depth of which is more than 10% of the thickness, with a limit of 0.5 mm.
- Superficial wear and tear (see § 2.1.4.), where the depth of the marks is more than 10% of the thickness, with a limit of 0.5 mm.
- Notches (see § 2.1.3.), the depth of which is more than 10% of the thickness, with a limit of 0.50 mm.
- Holes, the depth of which (see § 2.1.5.) is more than 10% of the thickness, with a limit of 0.50 mm
- Dents in the pipe wall (see § 2.1.6.).

3.2.2 Manufacturing defects

3.2.2.1 Incrustation with residual matter generated during extrusion, craters, pits, unfused elements (see § 2.2.3., 2.2.5.2., 2.2.6. and 2.2.7.)

A sample may present several of the above defects.

Let p be the depth of the defect and e the nominal thickness of the pipe.

Case 1 : $p > 0.1.e$

Any pipe which includes one of the above defects where the depth is more than 10% of the nominal thickness of the pipe is always considered to be defective.

Case 2 : $p \leq 0.1.e$

For a pipe which contains isolated defects², the depth of which is 10% of the nominal thickness or less, each defect is allocated a grade g depending on its largest dimension a , excluding the depth. The value of g in terms of a is defined in Table 1.

	POLYETHYLENE PIPES FOR UNDERGROUND NETWORKS FOR NATURAL GAS DISTRIBUTION QUALITY CONTROL OF PIPES	DOCUMENT NO.	Rev
		11-0326-02-07-02-003	0
		Page 17 of 19	

Table I

Largest dimension a of defects in mm	Grade
1.0 ≤ a < 2.0	5
2.0 ≤ a < 3.0	10
3.0 ≤ a < 4.0	25
4.0 ≤ a < 5.0	50
5.0 ≤ a < 6.0	51

Defects, the largest dimension of which is less than 1mm are not taken into account.

A pipe is considered to be defective when it presents a defect, the largest dimension of which is 6.0 mm or more.

A pipe is considered to be defective when the sum of the products of the grades g multiplied by the number of defects n detected along a length of 100 cm exceeds the value L defined in table 2 in terms of the diameter of the pipe.

Table 2

Nominal diameter de	$L = \sum(n.g)$
20	
32	20
62	40
90	

3.2.2.2 Continuous longitudinal marks inside and outside, cavities, marking too deep and indentations caused by marking tool.

Pipes presenting the following defects are classified as defective:

- Continuous longitudinal marks on the inside and outside which are 0.20 mm deep or more (see § 2.2.2.).
- Cavities (see § 2.2.8.).
- Marking too deep (see § 2.3.1.), where the depth is more than 0.20 mm.
- Indentations caused by the marking tool (see § 2.3.2.), where the depth is more than 0.20 mm.

4. ACCEPTANCE CRITERIA FOR BATCHES

4.1. CRITICAL DEFECTS

When a pipe presents one of the defects described in section 3.1., the batch is rejected.

² A defect is considered to be isolated if the gap between the closest edges of two defects is greater than the largest dimension of the defects. Otherwise, it is a single case defect.

Note : Porosity



POLYETHYLENE PIPES FOR
UNDERGROUND NETWORKS FOR
NATURAL GAS DISTRIBUTION
QUALITY CONTROL OF PIPES

DOCUMENT NO.

11-0326-02-07-02-003

Rev

0

Page 18 of 19

Rejection is confirmed if the water or volatile contents measured exceed the criteria laid down in the technical specification.

4.2 OTHER DEFECTS

The following rules apply to the sampling test³.

When examining the pipes comprising the sample batch, let n_1 be the number of defective pipes or rolls

if $n_1=0$ the batch is acceptable;

if $1 \leq n_1 < 3$ the batch is acceptable, but the defective pipes or rolls are eliminated; if

$n_1 \geq 3$ a second sample is taken from the batch presented following the procedures described previously, and the defective pipes or rolls are eliminated.

³Sampling: The sample comprises the pipes contained in a whole number of packaging units (crates or rolls) corresponding to 10% in excess of the total length of pipes presented. Examination of the appearance covers the surfaces of the internal and external walls. In the case of pipes rolled on a drum, the appearance is checked for each drum on the sections of pipes in the last layer of rolled coils, as well as those accessible from the side.



When examining the pipes comprising the second sampling, let n_2 be the number of defective pipes or rolls

if $n_2 = 0$ the batch is acceptable;

if $1 \leq n_2 < 3$ the defective pipes or rolls are eliminated;

if $n_2 \geq 3$ the batch is rejected. It may be sorted and, if necessary, the balance of the sorting operation may be presented again for testing.

	POLYETHYLENE PIPES FOR UNDERGROUND NETWORKS FOR NATURAL GAS DISTRIBUTION QUALITY CONTROL OF PIPES	DOCUMENT NO.	Rev
		11-0326-02-07-02-003	0
		Page 19 of 19	

	GREEN GAS LIMITED CITY GAS DISTRIBUTION PROJECT	
---	--	---

PE ACCESSORIES FOR UNDERGROUND NETWORKS FOR NATURAL GAS DISTRIBUTION					CLIENT JOB NO.	
					TOTAL SHEETS	20
DOCUMENT NO	11	0326	02	07	02	004

--	--	--	--	--	--

0	30.12.11	ISSUED FOR TENDER	PD	SSJ	SB
A	16.11.11	ISSUED FOR CLIENT COMMENTS	PD	SSJ	SB
REV	DATE	DESCRIPTION	PREP	CHK	APPR

**PE ACCESSORIES FOR UNDERGROUND NETWORKS FOR NATURAL GAS
DISTRIBUTION**



	PE ACCESSORIES FOR UNDERGROUND NETWORKS FOR NATURAL GAS DISTRIBUTION	DOCUMENT NO.	Rev
		11-0326-02-07-02-004	0
		Page 2 of 20	

TABLE OF CONTENTS

1.	SUBJECT AND AREA OF APPLICATION	4
2.	REFERENCE STANDARDS AND SPECIFICATIONS	4
3.	DEFINITIONS	5
3.1.	ELECTROFUSION ACCESSORY	5
3.2.	ELECTROFUSION SADDLE	6
3.3.	END TO END WELDING ACCESSORIES	6
4.	GENERAL SPECIFICATIONS	7
5.	MATERIALS	7
5.1.	GENERAL INFORMATION	7
5.2.	RAW MATERIAL SPECIFICATIONS	7
5.3.	SPECIFICATIONS FOR COMPONENTS MADE OF MATERIALS OTHER THAN POLYETHYLENE	8
6.	GENERAL ACCESSORY CHARACTERISTICS	8
6.1.	TECHNICAL INFORMATION	8
6.2.	APPEARANCE AND FINISH	9
6.3.	COLOUR	9
6.4.	JOIN APPEARANCE	9
6.5.	ELECTROFUSION ACCESSORY ELECTRICAL CHARACTERISTICS	10
6.6.	SUPPORT DRILLING EQUIPMENT	11
6.7.	BRANCHING SUPPORT AND SADDLE LOAD LOSS UNDER LOW PRESSURE	11
6.8.	ELECTROFUSION SLEEVE BLOCK	11
7.	GEOMETRICAL CHARACTERISTICS	11
7.1.	SIZE OF ELECTROFUSION SLEEVES	11
7.2.	ELECTROFUSION SADDLE MEASUREMENTS	12
7.3.	MEASUREMENTS OF ACCESSORY ENDS TO BE WELDED	13
8.	ACCESSORY MECHANICAL CHARACTERISTICS	14
9.	PHYSICAL CHARACTERISTICS	15
10.	PRODUCT APPROVAL	15
11.	MARKING	15
11.1.	ACCESSORY MARKING	15
11.2.	COMPLEMENTARY INFORMATION	16
12.	PACKAGING AND DELIVERY	16
13.	QUALITY CONTROL	16
13.1.	GENERAL RULINGS	16
13.2.	CONTROLS	17
13.3.	ACCEPTANCE OR REFUSAL	18
	ANNEX 1	19

	PE ACCESSORIES FOR UNDERGROUND NETWORKS FOR NATURAL GAS DISTRIBUTION	DOCUMENT NO.	Rev
		11-0326-02-07-02-004	0
		Page 3 of 20	

1. SUBJECT AND AREA OF APPLICATION

This specification has been established to define the requirements that must be met by injected moulded polyethylene accessories (PE) destined for the construction or the maintenance of underground networks for natural gas distribution where the maximum operating pressure (MOP) is equal to 6 bars.

It also defines some of the more general characteristics of materials used for accessory manufacturing and includes the appropriate classification model.

The specification also includes testing method parameters for the material in question.

All accessories included in these specifications are listed as follows:

- Electrofusion welded accessories
- Electrofusion welded saddles
- Accessories equipped with insertion connection for end to end welding and assembly using electrofusion-welded sleeve coupling.

This specification is limited to accessories with a nominal diameter of 225 mm and a working temperature between 0°C and +50°C.

PE and steel accessories with a tapered section and front section connections are not included in these specifications.

2. REFERENCE STANDARDS AND SPECIFICATIONS

EN 682	Air-tight rubber seals - specification for air-tight seal materials for gas and hydrocarbon fluid transfer piping
EN 1555-1	Plastic piping systems for combustible gas distribution. Polyethylene (PE). Part 1. General information
EN 1555-3	Plastic piping systems for combustible gas distribution. Polyethylene (PE). Part 3 . Accessories

	PE ACCESSORIES FOR UNDERGROUND NETWORKS FOR NATURAL GAS DISTRIBUTION	DOCUMENT NO.	Rev
		11-0326-02-07-02-004	0
		Page 4 of 20	

EN 1555-7 Plastic piping systems for combustible gas distribution. Polyethylene (PE). Part 7. Conformity evaluation.

ISO DIS 11413 Preparation of test assemblies between a polyethylene (PE) pipe and an electrofusion fitting.

ISO DIS 11414 Preparation of test assemblies between a pipe/pipe or pipe/fitting polyethylene (PE) by butt fusion

ISO DIS 12093 Format for a technical brochure for electrofusion joint characteristics.

ISO TR 13950 Electrofusion identification methods

CEI 60335-1 Safety standards for household appliances and similar equipment.

CEI 364 Electrical installations on buildings (including building sites and other temporary installations)

CEI 449 Voltage domains for building electrical installations.

ISO 14885 Polyethylene pipes for the supply of Gaseous Fuels-Specifications.

11-0326-02-07-02-001 to 11-0326-02-07-02-003

WGI technical specification: polyethylene piping for underground networks for natural gas distribution

11-0326-02-07-02-005 WGI technical specification: raw materials for manufacturing piping and accessories for underground networks for natural gas distribution.

3. DEFINITIONS

3.1. ELECTROFUSION ACCESSORY

This term covers all injected moulded polyethylene accessories equipped with a heated element designed to transform electrical energy into heat to create self-welding.

In certain exceptional cases, an accessory can present one or more smooth ends. In this case the accessory will provide for the requirements of each connection end as regards shape, measurement, and technical characteristics.

	PE ACCESSORIES FOR UNDERGROUND NETWORKS FOR NATURAL GAS DISTRIBUTION	DOCUMENT NO.	Rev
		11-0326-02-07-02-004	0
		Page 5 of 20	

3.2. ELECTROFUSION SADDLE

This term covers a saddle shaped injection moulded PE accessory that is equipped with one or several heating elements that convert electrical energy into heat. The released heat provides a fusion surface sufficiently large to ensure correct saddle-pipe assembly.

Electrofusion saddles can be subdivided into two categories:

- Wrap around Electrofusion saddle whose upper shell is brought against the pipe during welding using a fastening stirrup located on the lower part of the accessory to guarantee that the welding pressure is sufficient. Generally the stirrup is left in place after welding.
- Top load Electrofusion saddle where the welding pressure is obtained by pressing down on the saddle head using a fixing system (clamp) that is removed after welding is completed.

There are four different saddle types:

- Support This is an accessory designed for joining branch pipes and is equipped with a drill bit made to pierce the wall of the pipe; this bit remains in the saddle body after installation.
- Branch piping This accessory is designed for joining branch piping where an saddle additional bit is necessary to pierce the wall of the main pipe next to the branch.
- Ballooning This accessory provides the positioning of a sealing (or blocking) saddle balloon and that can be filled again after work completion.
- Repair saddle This accessory will seal/block any leaks on the pipe or will reinforce piping in the case of localised deterioration.

According to their leakage flow, the supports are divided into two model categories:

Model-1	Supports whose maximum immediate leak flow is practically zero at 5 bar pressure in the piping.
Model-2	Supports whose maximum immediate external leak flow never exceed 200 litres an hour at 5 bar pressure in the piping.

3.3 END TO END WELDING ACCESSORIES

This term describes injection moulded polyethylene accessories with smooth ends but not equipped with

	PE ACCESSORIES FOR UNDERGROUND NETWORKS FOR NATURAL GAS DISTRIBUTION	DOCUMENT NO.	Rev
		11-0326-02-07-02-004	0
		Page 6 of 20	

integrated heating elements. These are connected to the network by end-to-end welding using electrofusion sleeves.

In certain exceptional cases, an accessory can also present one or more electrofusion ends. In this case the accessory will provide for the requirements of each connection end in shape, measurement, and technical characteristics.

4.0 GENERAL SPECIFICATIONS

This specification is based on the series of EN 1555 standards, which standardise all the gas distribution network plastic piping systems.

The accessories described in this document comply with all prescriptions included in EN standard 1555-3, as well as all complementary requirements and/or options described in these WGI specifications.

The accessories are destined for use in gas distribution networks in piping in compliance with WGI specification 11-0326-02-07-02-001 to 11-0326-02-07-02-003

5.0 MATERIALS

5.1. GENERAL INFORMATION

The materials used for the manufacturing of the accessories must conform to the requirements demanded for components used in gas fuel distribution networks.

The accessory material that is in contact with the PE piping must not be composed of any material that will provoke a reduction in pipe performance, nor must it provoke cracking under stress.

All equipment shall be marked with inscription/description and specification in english language

5.2. RAW MATERIAL SPECIFICATIONS

The raw material PE, used for accessory production, shall be in compliance with all prescriptions in EN 1555-1 standards. It must be approved according to the prescriptions in WGI specification 11-0326-02-07-02-005

The raw material shall be class PE100.

The following are strictly forbidden:

- use of recycled raw materials
- mixing of different raw materials
- The addition of supplementary additives to the raw material.

	PE ACCESSORIES FOR UNDERGROUND NETWORKS FOR NATURAL GAS DISTRIBUTION	DOCUMENT NO.	Rev
		11-0326-02-07-02-004	0
		Page 7 of 20	

5.3. SPECIFICATIONS FOR COMPONENTS MADE OF MATERIALS OTHER THAN POLYETHYLENE

5.3.1. Metal parts

All metal parts subject to corrosion must be protected in an adequate manner

Metal parts must conform to prescribed standards of that particular material for gas distribution, for quality levels, size/gauge and measurements.

Cast iron, aluminium and its alloys are not authorised for use.

5.3.2. Elastomers

Elastomer air and watertight seals, like all other elements manufactured in this material, must comply with the prescriptions of EN 682 standards.

5.3.3. Other materials

All other materials used are in compliance with the prescriptions described in paragraph 5.1. The accessories included in the paragraph comply with the requirements of this specification and are adapted for all general use for natural gas distribution.

6. GENERAL ACCESSORY CHARACTERISTICS

6.1 TECHNICAL INFORMATION

The manufacturer must supply a technical information dossier composed and including the same material and presented in the same manner, in compliance with the prescriptions of the ISO DIS standard I2093.

This dossier must mention all of the following information for each accessory:

- PE raw material used
- Measurements and tolerances
- Domain of application (temperature and pressure limits, SDR and ovalisation)
- Assembly instructions
- Welding instructions (welding parameters and limits)
- Test results attesting to the accessory conformity standard: c.f. EN standard 1555-3 for test descriptions.

For electrofusion accessories, the manufacturer must also supply the SDR series for the pipes, which will be used together with their accessory, according to their thickness.

In addition, for the saddles:

- The attaching method (tools necessary and/or lower shell)

	PE ACCESSORIES FOR UNDERGROUND NETWORKS FOR NATURAL GAS DISTRIBUTION	DOCUMENT NO.	Rev
		11-0326-02-07-02-004	0
		Page 8 of 20	

- saddle category (refer to 3.2)
- Maximum saddle height (H in figure 2)
- the height of the branch pipe for supports (h in figure 2)

For all smooth ended accessories, the manufacturer must also supply the SDR series of connections; the accessory must be guaranteed for use on piping of the same class.

In the case of welding parameter modification, size or raw material changes. the manufacturer must include a new technical dossier providing proof that the accessory in question is still compliant with the specification prescriptions.

Testing assemblies will take into consideration manufacturing tolerance, assembly tolerance and the variations in environmental temperature corresponding with the conditions where the accessories will be in use. The manufacturer must observe all methods recommended for polyethylene accessory installation as shown in the WGI specifications.

The accessories will be tested exclusively using piping in compliance with WGI specifications concerning PE piping (11-0326-02-07-02-001 to 11-0326-02-07-02-003).

The assembly of piping and accessories manufactured and used in the tests must be in compliance with the manufacturer's technical instructions and the limits of use conditions. When the test assemblies are carried out, the manufacturing and assembly tolerances must be taken into consideration. Samples destined for assembly testing with electrofusion accessories must be prepared according to standard ISO DIS 11413. End- to-end welded samples must be prepared according to standard ISO DIS 11414.

6.2. APPEARANCE AND FINISH

The internal and external surfaces of the accessories must be smooth, clean and free of all scratching, pitting and other surface faults that can possibly reduce accessory and assembly performance.

No element of any accessory must show any signs of damage: scratching, scraping, piercing, blisters, bloating, denting, holes, cracks or other faults that can reduce required performance.

It must be possible to place the accessory on the pipe or on another accessory without moving the electric winding or the air/water tight seals etc. and this must respect the tolerance permitted for piping and accessories.

6.3. COLOUR

All accessories will be black. If agreed previously, they can also be coloured yellow or orange.

6.4. JOIN APPEARANCE

After welding, when examined visually without a magnifying glass, the internal and external surfaces of

	PE ACCESSORIES FOR UNDERGROUND NETWORKS FOR NATURAL GAS DISTRIBUTION	DOCUMENT NO.	Rev
		11-0326-02-07-02-004	0
		Page 9 of 20	

the pipes and accessories must appear free of welding exudation outside the accessory limits (unless identified by the accessory manufacturer as normal, or carried out deliberately as a welding test, but on condition that there is no wiring position change inside the electrofusion accessories that could provoke a short-circuit). Internal surfaces of all adjacent piping must remain identical to the previous condition before welding.

6.5 ELECTROFUSION ACCESSORY ELECTRICAL CHARACTERISTICS

6.5.1. General information

The accessories include an electrical system as described in the standards CENELEC 60335-1, CEI 364 and CEI 449.

This system is equipped with an appropriate electrical protection for the voltage and intensity of the current in use, and adapted to the characteristics of the electrical supply line.

For voltage over 24 V protection is essential against direct contact with the active parts (conductors on line). The type of protection in question depends on the local site conditions.

6.5.2. Classification

Electrofusion accessories are divided into three classes according to the voltage and/or current characteristics.

Class A Electrical supply based on voltage set between 8V and 42 V

Class B Electrical supply based on voltage set between 42 V and 220 V

Class C Electrical supply based on power supply settings.

All supplies, unless otherwise stipulated in the order, concern Class A accessories.

The power required for electrofusion accessory welding must not exceed 3kW during welding operations.

Unless stipulated otherwise in the order, only ‘wrap-around’ saddles can be supplied (refer to par. 3.2.)

Unless otherwise agreed between WGI and the supplier, all electrofusion accessories must be “single wire” type.

6.5.3. Connectors

Electrical connectors installed on electrofusion accessories must comply with the diagram included in Annex 1 with these specifications, also including constant current supply where this is the case. The state of the connector terminal surface must offer the minimum possible contact resistance during voltage cable joining.

6.5.4. Protection against overheating

	PE ACCESSORIES FOR UNDERGROUND NETWORKS FOR NATURAL GAS DISTRIBUTION	DOCUMENT NO.	Rev
		11-0326-02-07-02-004	0
		Page 10 of 20	

Electrofusion accessories that can only be welded once are equipped with a lock system which prevents re-welding.

Electrofusion accessories that cannot be re-welded immediately after initial welding are equipped with an incorporated security system in their welding program: that is they cannot weld while the wire is still hot. If the welding program does not possess this lock system, the electrofusion accessory must absolutely be protected against a second or several welding cycles whatever the temperature of the winding wire.

6.6. SUPPORT DRILLING EQUIPMENT

The support drilling equipment has been designed so that during drilling the maximum immediate leak flow will never exceed 200 litres per hour at 5 bar pressure, in the main pipe. According to this flow rate, the supports are divided into two categories:- models 1 and 2 (refer to par. 3.2.) The required model will be specified when ordered.

The bell drill is equipped with a maneuvering opening for the insertion of a 17 mm hexagonal spanner. The bell drill path is limited at the top and bottom by a limit block.

The drill mechanism is designed so that no additional tools (except the hexagonal spanner described above) are necessary for carrying out drilling operations.

6.7 BRANCHING SUPPORT AND SADDLE LOAD LOSS UNDER LOW PRESSURE

The maximum load loss measured with natural gas at an inlet pressure of 20 mbar must not exceed the values listed below.

Flow m ³ /hr	Saddle Type	Maximum load loss, Mbar
	32x20	
	63x20	
	63x32	
	90x32	
	90x63	

6.8. ELECTROFUSION SLEEVE BLOCK

All electrofusion sleeves are equipped with an immovable block in the centre of the sleeve.

7. GEOMETRICAL CHARACTERISTICS

7.1. SIZE OF ELECTROFUSION SLEEVES

The sizes of the electrofusion accessory sleeves and their tolerance limits are described in chapter "Geometrical characteristics" of EN standard 1555-3.

	<p align="center">PE ACCESSORIES FOR UNDERGROUND NETWORKS FOR NATURAL GAS DISTRIBUTION</p>	DOCUMENT NO.	Rev
		11-0326-02-07-02-004	0
		Page 11 of 20	

They are controlled according to the method described in the specification standard. Any possible sealing plugs are removed from the sleeve 4 hours before the size control check. Measurements are controlled without the plugs inserted.

The main symbols are shown in the figure 1 below:

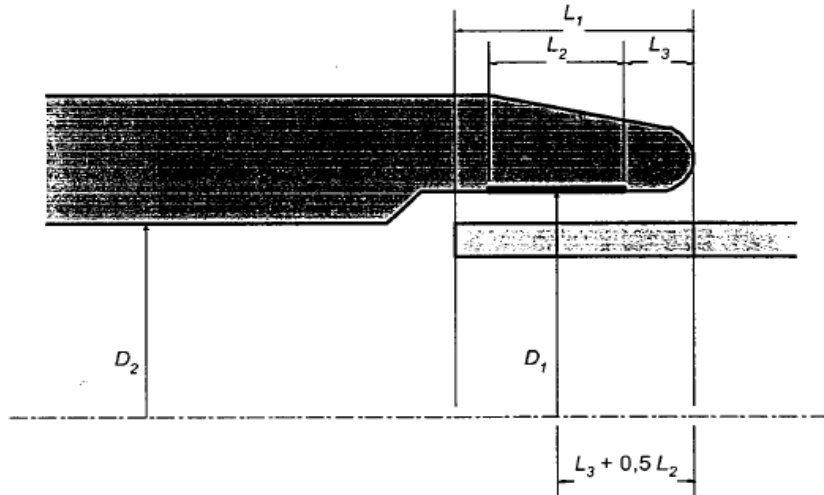

- D1 The “average internal diameter in the welding zone” — that is: the average internal diameter measured in a parallel plane to the opening plane, at a distance of $L_3 + L_2/2$ of the latter.
- D2 “Minimum drilling/boring” — that is the minimum diameter of the draining canal through the body of the accessory.
- L1 “penetration depth” of the pipe or the inserted (male) end of the accessory
- L2 “Nominal length of the welding zone” that corresponds with the length subject to heating.
- L3 “Nominal non-heated entry/inlet length of the sleeve”. This refers to the distance between the tip of the accessory and the beginning of the welding zone.

7.2. ELECTROFUSION SADDLE MEASUREMENTS

The measurements of the electrofusion saddles and their tolerance limits are described in EN standard 1555-3

They are controlled according to the method described in the specification standard. Any possible sealing plugs are removed from the sleeve 4 hours before the size control check. Measurements are controlled without the plugs inserted.

The main symbols are shown in the figure 2 below:

	PE ACCESSORIES FOR UNDERGROUND NETWORKS FOR NATURAL GAS DISTRIBUTION	DOCUMENT NO.	Rev
		11-0326-02-07-02-004	0
		Page 12 of 20	

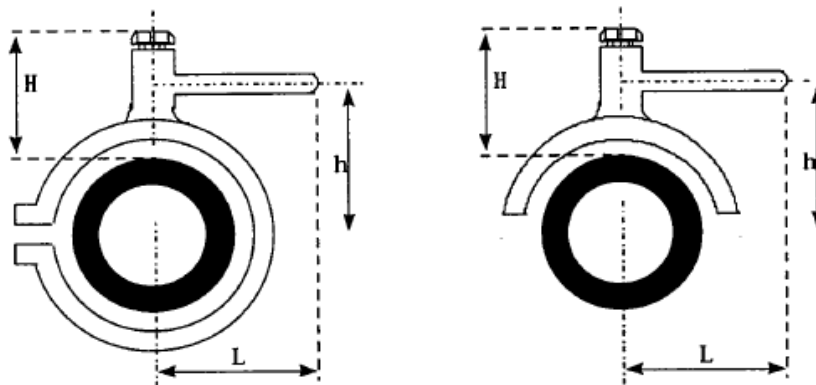

FIG.2

- H The “height of the saddle” — that is the distance between the upper generator of the main pipe and the top of the branch pipe saddle
- h The “height of the branch pipe” — that is the distance between the axis of the main pipe and the axis of the branch pipe
- L The “width of the branch pipe saddle” — that is the distance between the axis of the pipe and the surface plane of the branch pipe opening

7.3. MEASUREMENTS OF ACCESSORY ENDS TO BE WELDED

The measurements of the ends and their tolerance limits are described in EN standard 1555-3.

They are controlled according to the method described in these specification standards. Any possible sealing plugs are removed from the sleeve 4 hours before the size control check. Measurements are controlled without the plugs inserted.

The measurements and main symbols used in this specification are shown in the figure 3 below:

	PE ACCESSORIES FOR UNDERGROUND NETWORKS FOR NATURAL GAS DISTRIBUTION	DOCUMENT NO.	Rev
		11-0326-02-07-02-004	0
		Page 13 of 20	

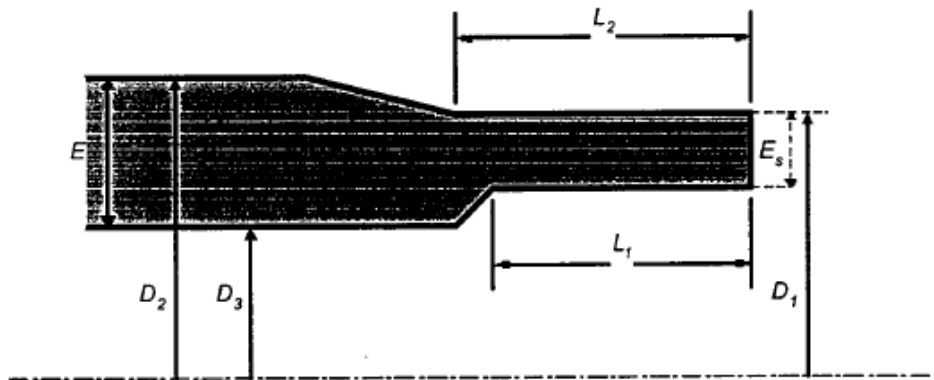



FIG.3

- D1 The “average external diameter of the end to be welded measured on any plane parallel to the inlet/entry plane at a distance where this plane does not exceed L_2 (tubular section).
- D2 The “average external diameter of the body” of the tip of the accessory.
- D3 ‘Minimum drilling/boring’ — that is the minimum diameter of the passage through the body of the accessory. Measuring of the diameter must not include any ribbing due to welding.
- E “Thickness of the accessory body wall” — that is: the thickness measured at any point of the accessory wall.
- Es “Thickness of the end to be welded” measured at any point but where the distance does not exceed L_1 (length that can be cut) compared to the inlet! entry plane, must be equal to the thickness of the nominal pipe wall.
- L1 The “cuttable section” of the end to be welded — that is the initial depth of the tip of the insertion section, necessary for end-to-end welding or for starting an end-to- end weld again.
- L2 The “tubular section” of the end to be welded — that is the initial length of this section. This tubular section permits the following in all types of combination:
- Use of the clamp stirrups, as is essential for end-to-end welding, or for electrofusion.
 - Assembly using electrofusion sleeves.

8. ACCESSORY MECHANICAL CHARACTERISTICS

	PE ACCESSORIES FOR UNDERGROUND NETWORKS FOR NATURAL GAS DISTRIBUTION	DOCUMENT NO.	Rev
		11-0326-02-07-02-004	0
		Page 14 of 20	

All accessories must obey the requirements and tests described in the chapter concerning the mechanical characteristics of EN standard 1555-3. They must also comply with the hydrostatic test conditions described in the same standard.

They must be controlled as described in the same standard.

9. PHYSICAL CHARACTERISTICS

All accessories must obey the requirements and tests described in the chapter concerning the mechanical characteristics of EN standard 1555-3

They must be controlled as described in the same standard

10. PRODUCT APPROVAL

The product will be approved by the Owner/ owner representative if all results of the tests, controls and checking prescribed by this specification are satisfying.

The manufacturer will provide a complete approval dossier including all the product characteristics specified in 6.1. (technical dossier) and the results of tests prescribed in these specifications. The number of tests run on the product must comply with EN standard 1555-7. The results of these tests described in the approval dossier must be confirmed by the Owner/ owner representative authorised laboratory. Hydraulic testing must be continued until the rupture of at least two test samples for each set of tests. (max. 2000 hours).

All changes made to the approved product must be communicated to the Ovine, and this entails further control checks for approval.

Any requirement not observed or test missing from this specification will result in the withdrawal of the product approval and can even result on annulment of contract.

11 MARKING

11.1. ACCESSORY MARKING

11.1.1. Identification marking will be made directly on the accessory. The system used to make the product must not provoke cracking or other faults. All marking must be permanently legible for the product life under standard stocking conditions, exposure to external weather conditions, treatment, installation, and use.

11.1.2. Where the products are printed, the colour of the printed identification mark must be different from that of the basic product colour.

11.1.3. Marking quality and size must be of a standard that can be read with the naked eye without magnification.

No marking must be printed on the minimum length of the insertion section of accessories.

	<p align="center">PE ACCESSORIES FOR UNDERGROUND NETWORKS FOR NATURAL GAS DISTRIBUTION</p>	DOCUMENT NO.	Rev
		11-0326-02-07-02-004	0
		Page 15 of 20	

11.1.4. Each accessory must be marked with at least the obligatory details required by EN standard 1555-3. The marking must be printed on the accessory itself or on a label as shown in the standard described above

The SDR pipe range that are to be fitted with these accessories must be clearly marked on the fitting. Details must include: each SDR value, or the upper and lower value of the permitted SDR range.

11.2. COMPLEMENTARY INFORMATION

All complementary information on welding conditions (welding time and cooling time) can also be described on a label affixed to the accessory or delivered with the accessory.

12 PACKAGING AND DELIVERY

Normally all accessories are packed separately in plastic sheeting and/or cardboard boxes. Sometimes they can be loosely packed together where there is no danger of damage or deterioration or loss of loose parts.

All boxes and plastic sheeting must be marked with at least one label showing the manufacturer's name, the product type, part measurements, and number of single parts contained in the box or bag, plus all details necessary for stocking and stock expiry dates.

All electrofusion accessories must be printed with a bar code and an individual magnetic card. The magnetic card contains the welding parameters that have been encoded in the magnetic track, as well as the bar code printed on the card. Coding must be carried out according to prescriptions included in ISO TR 13950 standards.

With regard to stocking guarantee, accessories must correspond with the prescriptions of the local laws & regulations if any. If the guarantee period decided by the manufacturer is shorter than that in these document, the Owner/ owner representative must be informed in writing at the time of the offer.

13 QUALITY CONTROL

13.1. GENERAL RULINGS

13.1.1. Manufacturer's responsibility

The manufacturer is entirely responsible for the quality of the PE accessories manufactured by his firm. All control checks prescribed above do not relieve him of this responsibility.

To ensure that all PE accessories are in compliance with the specification in all aspects, they must be controlled by the plant control service, which must be independent from the manufacturing department.

All PE accessories supplied are guaranteed for a one-year period after application for use, that is a maximum of three years after the date of production.

13.1.2. Quality assurance

	PE ACCESSORIES FOR UNDERGROUND NETWORKS FOR NATURAL GAS DISTRIBUTION	DOCUMENT NO.	Rev
		11-0326-02-07-02-004	0
		Page 16 of 20	

The manufacturer must have some form of quality control to ensure that products comply with EN standards 29001 or 29002. The quality assurance manual must be made available to the Owner/ owner representative Control Service or an external Control laboratory appointed by him.

The system of quality assurance must be certified by an authorised body.

13.2. CONTROLS -

13.2.1. Control testing by the manufacturer

13.2.1.1. By material batch.

The manufacturer demands a certificate from the raw material manufacturer including the following:

- Fluid index
- Water content
- Volume mass
- Carbon black or yellow stabilising agent content
- Carbon black or yellow stabilising agent quality
- OIT value (thermal stability)

13.2.1.2. By accessory batch

The manufacturer must run control checks as follows:

- Appearance / colour
- Measurements
- Hydraulic testing
- Electrical resistance
- Printing/markings.

Control checks and the number of tests must be carried out according to the prescriptions of the EN standard 1555-3

Also refer to table N° 8, paragraph 4.2.3. "Lot release tests" of EN standard 1555-7.

The results must be written out in documents that contain the complete identification of the accessory batch.

These documents must be made immediately available for the Owner representative.

13.2.2. Plant Reception by the Owner Control Service representative

13.2.2.1. General information

	PE ACCESSORIES FOR UNDERGROUND NETWORKS FOR NATURAL GAS DISTRIBUTION	DOCUMENT NO.	Rev
		11-0326-02-07-02-004	0
		Page 17 of 20	

All quality controls must be run in the presence of the Owner Control Service representative.

All tests and control checks must comply with appropriate standard prescriptions and with the specific specifications established with the order.

At each visit by the Owner representative, the manufacturer must provide, free of charge, all means and personnel necessary for running the established control checks.

While the order is under production, the Owner representative must have access to stocking installations of all raw materials before manufacturing, manufacturing and control installations, as well as the accessory stocking areas for any control checks he is responsible for.

During his visits, the Owner representative will receive a certificate as soon as he reaches the plant for each batch of accessories presented for reception.

Each time this is requested by the Owner representative, the manufacturer must provide recent reports of all control checks and measuring instrument results and testing results.

13.2.2.2. Convocation for reception

Convocation instructions for reception are to be defined with the order.

13.2.2.3. Reception control checks

For each accessory batch or any fractions of the batch, minimal batch sampling is established in annexed enclosure 3. These control checks and tests are to be run according to the prescriptions of EN standard 1555-3

13.3 ACCEPTANCE OR REFUSAL

13.3.1. Appearance, measurements and marking

Any requirements not supplied will lead to the refusal of the complete batch. However in the case where a batch is refused, it can be presented for approval again after a control check, on agreement with the Owner/Owner representatives Control Service.

13.3.2. Control check on characteristics

All results that do not comply with the specification prescriptions and the particular specifications requested with the order, demand counter-testing on at least double the number of the samples previously tested. If the undesirable result is confirmed, then the batch is refused permanently. If the result is positive, then the batch will be accepted.

As a complementary control check, other analyses and/or tests can be run after common agreement and at the manufacturer's cost.

	PE ACCESSORIES FOR UNDERGROUND NETWORKS FOR NATURAL GAS DISTRIBUTION	DOCUMENT NO.	Rev
		11-0326-02-07-02-004	0
		Page 18 of 20	

ANNEX 1

CONNECTOR FOR ELECTROFUSION ACCESSORIES

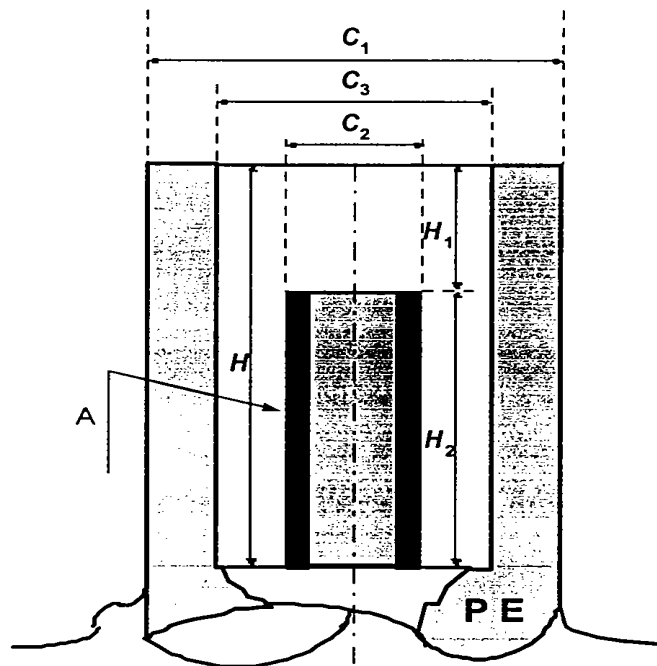

Symbols

C1	External diameter of connector	$C1 \geq 11.8 \text{ mm}$
C2	Diameter of active part of connector	$C2 = 4.0 \pm 0.03 \text{ mm}$
C3	Internal diameter of connector	$C3 = 9.5 \pm 1.0 \text{ mm}$
C4	Max. Diameter of active part foot	$C4 \geq 6.0$
H	Connector internal depth	$H > 12.0$
		$H > H1 + H2$
H1	Distance between upper part of connector and active part	$H1 = 3.2 \pm 0.5$
H2	Height of active part	$H2 \geq 7.0 \text{ mm}$
A	Active zone.	



PE ACCESSORIES FOR
UNDERGROUND NETWORKS FOR
NATURAL
GAS DISTRIBUTION

DOCUMENT NO.

11-0326-02-07-02-004

Rev

0

Page 19 of 20

RECEPTION AT MANUFACTURER'S PLANT.

Characteristics	Reference EN 1555-3	Minimum drill tests / frequency	N° of samples	N° of measured samples
Appearance /colour	5.2 /5.3	1 x /size/product type / internal space	10	1
Measurements	6	1 x /size/product type / internal space	10	1
Thermal stability (OIT)	8.2	1 x batch	1	1
Meltmass flow rate (MFR)	8.2	1 x batch	1	1
Electrical resistance	5.6	1x/size/product type/internal space	5	1
Cohesion resistance	7.2	1x/size/product type	2	1
End-to-end seam resistance to traction (cohesion resistance)	7.2	1x/size/product type	2	1
Shock resistance	7.2	1x/size/product type	1	1
Load loss	7.2	1x/size/product type	1	1
Marking	10.2	1x/size/product type	1	1

	<p align="center">PE ACCESSORIES FOR UNDERGROUND NETWORKS FOR NATURAL GAS DISTRIBUTION</p>	DOCUMENT NO.	Rev
		11-0326-02-07-02-004	0
		Page 20 of 20	



**GREEN GAS LIMITED
CITY GAS DISTRIBUTION PROJECT**



POLYETHYLENE COMPOUNDS FOR MANUFACTURE OF PIPES AND FITTINGS FOR UNDERGROUND NETWORKS FOR NATURAL GAS DISTRIBUTION ACCEPTANCE PROCEDURE	CLIENT JOB NO.	
	TOTAL SHEETS	12

DOCUMENT NO	11	0326	02	07	02	005
-------------	----	------	----	----	----	-----

<p>REVISIONS</p>					
------------------	--	--	--	--	--

0	30.12.11	ISSUED FOR TENDER	PD	SSJ	SB
A	16.11.11	ISSUED FOR CLIENT COMMNETS	PD	SSJ	SB
REV	DATE	DESCRIPTION	PREP	CHK	APPR

POLYETHYLENE COMPOUNDS FOR MANUFACTURE OF PIPES AND FITTINGS FOR UNDERGROUND NETWORKS FOR NATURAL GAS DISTRIBUTION ACCEPTANCE PROCEDURE

TABLE OF CONTENTS

1.	SUBJECT	4
2.	REFERENCES: STANDARDS AND SPECIFICATIONS	4
3.	DEFINITIONS AND SYMBOLS	5
3.1.	LOWER CONFIDENCE LIMIT (LCL)	5
3.2.	MINIMUM REQUIRED STRENGTH (MRS 10)	6
3.3.	PE 100	6
3.4.	BATCH OF COMPOUND	6
3.5.	BATCH OF PIPES	6
4.	GENERAL SPECIFICATIONS	6
5.	SUMMARY OF THE PROCEDURE	7
5.1.	GENERAL	7
5.2.	APPLICATION FOR APPROVAL	7
6.	TECHNICAL FILE	7
6.1.	EVALUATION	7
6.2.	ADDITIONAL TESTS	8
7.	CONFIRMATION TESTS	9
8.	FOLLOW-UP	10
8.1.	TECHNICAL DATA SHEET	10
8.2.	CONTINUITY OF THE COMPOUND	10
	APPENDIX 1	12

	POLYETHYLENE COMPOUNDS FOR MANUFACTURE OF PIPES AND FITTINGS FOR UNDERGROUND NETWORKS FOR NATURAL GAS DISTRIBUTION ACCEPTANCE PROCEDURE	DOCUMENT NO.	REV
		11-0326-07-02-005	0
		SHEET Page 3 of 12	

The information contained in this document should be treated as confidential and is to be considered as the exclusive property of WGI.

Direct or indirect use of this document or any part of it is only allowed for WGI productions.

1 SUBJECT

This specification describes the procedure to be followed for acceptance of a polyethylene (PE) compound for manufacture of natural gas underground distribution systems.

This specification also gives the minimum requirements which have to be met by PE compounds for manufacture of pipes, fillings and valves and for the construction of underground distribution systems for natural gas.

The compounds that meet this specification must at the minimum be PE 100.

The color shall be orange in accordance with the local requirements.

2. REFERENCES: STANDARDS AND SPECIFICATIONS

This section contains the list of standards and specifications referred to in this specification.

EN 728: 1997	Plastics piping and ducting systems - Polyolefin pipes and fillings - Determination of oxidation induction time.
prEN 1555-1	Plastics piping systems for the supply of gaseous fuels - Polyethylene (PE) - Part 1: General
prEN 1555-7	Plastics piping systems for the supply of gaseous fuels - Polyethylene (PE) - Part 7: Assessment of conformity.
prEN 12099	Plastics piping systems - Polyethylene piping materials and components - Determination of volatile content.
prEN 12118	Plastics piping systems - Determination of moisture content in plastics by conformity.
EN ISO 12162: 1995	Thermoplastics materials for pipes and fittings for pressure applications - Classification and designation - Overall service (design) coefficient.

	POLYETHYLENE COMPOUNDS FOR MANUFACTURE OF PIPES AND FITTINGS FOR UNDERGROUND NETWORKS FOR NATURAL GAS DISTRIBUTION ACCEPTANCE PROCEDURE	DOCUMENT NO.	REV
		11-0326-07-02-005	0
		SHEET Page 4 of 12	

EN ISO 13478: 1997	Thermoplastics pipes for the conveyance of fluids - Determination of resistance to rapid crack propagation (RCP) - Full-scale test (FST).
EN ISO 13479: 1997	Thermoplastics pipes for the conveyance of fluids - Determination of resistance to crack propagation (RCP) - Test method for slow crack growth on notched pipes (notch test).
EN 45001: 1990	General criteria for the operation of testing laboratories.
ISO 1133: 1997	Determination of the melt mass-flow rate (MFR) and the melt volume-flow rate (MVR) of thermoplastics.
ISO 6964: 1996	Polyolefin pipes and fittings - Determination of carbon black content by calcination and pyrolysis Test method and basic specification.
ISO/DIS 9080	Plastics piping and ducting systems-Determination of the long-term hydrostatic strength of thermoplastics materials in pipe from by extrapolation.
ISO 11420: 1996	Method for the assessment of the degree of carbon black dispersion in polyolefin pipes, fittings and compounds.
ISO 13477: 1997	Thermoplastics pipes for the conveyance of fluids - Determination of resistance to rapid crack propagation (RCP) - Small-scale-steady-state test (S4 test).
IS 14885	Polyethylene Pipes for the Supply of Gaseous Fuels-Specification
11-0326-02-07-02-001 to 11-0326-02-07-02-003	Polyethylene pipes for underground networks for natural gas distribution
11-0326-02-07-02-004	PE Accessories for underground networks for natural gas distribution

3. DEFINITIONS AND SYMBOLS

3.1. LOWER CONFIDENCE LIMIT (LCL)

A quantity with the dimensions of stress, in megapascal, which can be considered as a property of the

	POLYETHYLENE COMPOUNDS FOR MANUFACTURE OF PIPES AND FITTINGS FOR UNDERGROUND NETWORKS FOR NATURAL GAS DISTRIBUTION ACCEPTANCE PROCEDURE	DOCUMENT NO.	REV
		11-0326-07-02-005	0
		SHEET Page 5 of 12	

material under consideration and represents the 97.5% lower confidence limit of the predicted long-term hydrostatic strength at a temperature of 20 degree C for 50 years with internal water pressure.

3.2. MINIMUM REQUIRED STRENGTH (MRS 10)

Standardised class of compounds for which the LCL is equal to 10.

3.3. PE 100

Standard designation for PE compounds in class MRS 10.

For such PE compounds, the long-term hydrostatic strength — calculated and classified according to the standardised method (ISO 9080 and ISO 12162) for a temperature of 20°C, a period of 50 years and a reliability of 97.5 % — must be at least 10 MPa.

3.4. BATCH OF COMPOUND

By batch of compound is meant a homogeneous quantity of PE compound of the same origin and of a particular brand.

The batch must be registered under a single identification number (batch number) which leaves no doubt as to the origin, identity and date of manufacture of the compound.

3.5. BATCH OF PIPES

By batch of pipes is meant a homogenous lot of pipes with identical dimensions, made in a continuous process by the same extrusion machine and from the same batch of compound.

4 GENERAL SPECIFICATIONS

The PE compounds that are acceptable according to the requirements of this specification must conform to the requirements for PE 100 described in prEN1555-1.

If the proposed compound is destined for manufacture of pipes, then the acceptance procedure is carried out as described in this specification.

If the proposed compound is destined for manufacture of fittings, then the first stage (section 6) of this acceptance procedure is carried out, after which type tests are carried out on the fittings manufactured from the material concerned. An independent laboratory appointed by Owner/ owner representative will then evaluate whether conformity with the characteristics mentioned in the technical file has been proved, on the basis of the provisions of prEN 1555-7 and WGI specification 11-0326-02-07-02-004.

	POLYETHYLENE COMPOUNDS FOR MANUFACTURE OF PIPES AND FITTINGS FOR UNDERGROUND NETWORKS FOR NATURAL GAS DISTRIBUTION ACCEPTANCE PROCEDURE	DOCUMENT NO.	REV
		11-0326-07-02-005	0
		SHEET Page 6 of 12	

5. SUMMARY OF THE PROCEDURE

5.1. GENERAL

The acceptance procedure for PE compounds comprises two stages, namely the evaluation of the technical file and the confirmation tests. The different steps are carried out in the order described below.

The tests which form part of the technical file are carried out on pipes or samples supplied by the compounds manufacturer. In principle, all tests mentioned in the technical file are carried out on pipes from the same batch.

The tests mentioned in chapter 7 are carried out on pipes manufactured by a pipe manufacturer chosen by Owner/ Owner Representative .

The tests mentioned in chapter 6.1 (table 1), 6.2 and 7 are carried out in a laboratory appointed by Owner/ Owner Representative.

5.2. APPLICATION FOR APPROVAL

A manufacturer that wishes to have a certain PE compound classified for the manufacture of PE gas components must submit a written application to Owner.

This application must be accompanied by a clear description of the compound concerned, including the technical characteristics.

All correspondence must be in English.

6. TECHNICAL FILE

6.1. EVALUATION

If the application is taken into consideration by Owner/ Owner Representative, the compound manufacturer must submit a technical file to a laboratory appointed by Owner/ Owner Representative.

This technical file must include the following information:

- name and class of the PE compound;
- technical characteristics of the compound, with reference to the standard;
- a dossier with test results, from an independent laboratory, showing that the proposed compound meets the requirements of prEN 1555-1 for a PE 100 compound. The dossier must also state which tests have been carried out on the same batch of pipes or test samples, including the identification of their origin.

The laboratory chosen by Owner/ Owner Representative will also evaluate the conformity of this dossier, taking the following rules into account:

a) If the tests mentioned in the technical file have been carried out by a laboratory accredited according to EN 45001, and if the tests have been carried out on the same batch of pipes for the required diameter and

	POLYETHYLENE COMPOUNDS FOR MANUFACTURE OF PIPES AND FITTINGS FOR UNDERGROUND NETWORKS FOR NATURAL GAS DISTRIBUTION ACCEPTANCE PROCEDURE	DOCUMENT NO.	REV
		11-0326-07-02-005	0
		SHEET Page 7 of 12	

wall thickness, then the evaluation will be limited to an examination of the dossier in accordance with the provisions of prEN 1555-1 and the quantity of test samples laid down in 1555-7;

b) If the tests mentioned in the technical file have been carried out by a laboratory that is not accredited according to EN 45001 and/or on different batches of pipes for the same diameters/wall thickness, then the evaluation will be done on the basis of further tests in order to confirm the characteristics mentioned in the technical file.

c) The characteristics for rapid crack propagation (RCP) and slow crack propagation (SCG), as mentioned in the technical file, must comply with the requirements of the standard. Furthermore, the requirements of table 1 must be met:

Characteristic	Requirement	Standard
PcS4	DN 250- SDR 11 0°C - > 3,5 bar	ISO 13477
PcFS	DN 250- SDR 11 0°C-> 15 bar	EN ISO 13478
SCG	DN250-SDR11 80°C-σ4,6->500h	EN1SO13479

The tests mentioned in table I must be carried out by an independent laboratory appointed by Owner/ Owner Representative. The three series of tests must be carried out on the same batch of pipes.

If it emerges from the evaluation of the technical file that conformity with prEN 1555-1 is guaranteed, then the next stage of the procedure can commence, as described in section 7.

6.2. ADDITIONAL TESTS

6.2.1. General

If from the evaluation L emerges that the dossier submitted is incomplete or does not offer the necessary guarantees of conformity with the standard, then additional tests will be carried out by the laboratory appointed by Owner, at the cost of the compound manufacturer.

	POLYETHYLENE COMPOUNDS FOR MANUFACTURE OF PIPES AND FITTINGS FOR UNDERGROUND NETWORKS FOR NATURAL GAS DISTRIBUTION ACCEPTANCE PROCEDURE	DOCUMENT NO.	REV
		11-0326-07-02-005	0
		SHEET Page 8 of 12	

The same procedure will be followed if the technical file has been drawn up by a laboratory that is not accredited and/or if several batches of pipes have been used for each diameter/wall thickness in carrying out the tests.

6.2.2. Delivery of the pipes

The required batch of pipes must be delivered by the compound manufacturer, the pipes having been produced by a pipe manufacturer who at that moment is a Owner/ owner representative supplier.

The number of pipes must be based on the numbers and frequencies mentioned in prEN 1555-7.

If the technical file is based on tests carried out by a non-accredited laboratory and/or carried out on several batches of pipes per diameter/wall thickness, then the tests will repeated on at least half of the required test samples; if the number thus calculated is not a whole number, the number of test samples taken will be equal to the next whole number.

6.2.3. Test results

If from the additional tests it appears that conformity with prEN 1555-1 is guaranteed, then the next phase of the procedure can commence, as described in section 7.

If despite the additional tests no unambiguous decision can be taken regarding the conformity of the compound, then further additional tests will be carried out, until the number of test samples is at maximum equal to the number specified in the standard concerned. For this purpose, the manufacturer must keep sufficient pipes of the same batch in reserve.

If the evaluation is still not positive after the maximum number of samples has been tested, then the compound will be considered as not accepted.

7 CONFIRMATION TESTS

The second stage of the acceptance covers the industrial production of pipes, the verification of the characteristics, the laying of the pipes and the fusion to existing PE systems.

This second stage of the acceptance is carried out by Owner/ owner representative.

Before this stage can commence, the manufacturer must provide Owner/ owner representative with a technical data sheet (see appendix 1) showing the limit values for the characteristics of the compound concerned.

For the purpose of carrying out this part of the procedure, Owner/ owner representative will order a batch of pipes from one of its pipe manufacturers. After verification of the characteristics in the factory and

	POLYETHYLENE COMPOUNDS FOR MANUFACTURE OF PIPES AND FITTINGS FOR UNDERGROUND NETWORKS FOR NATURAL GAS DISTRIBUTION ACCEPTANCE PROCEDURE	DOCUMENT NO.	REV
		11-0326-07-02-005	0
		SHEET Page 9 of 12	

confirmation by an independent laboratory, the pipes will be installed in the Owner/ owner representative gas distribution network, taking into account the following aspects:

- Any problems with delivery and with extrusion of the compound will be noted.
- The limits of the characteristics mentioned in the technical data sheet.
- For characteristics not included in the technical data sheet, the measured value may deviate by max. 30% from the average values mentioned in the technical file, to the extent that these are relevant and not in conflict with the requirements of the standard.
- Any problems with laying or welding or connecting the pipes; these will be noted.

If from the test results it appears that the characteristics of the compound and/or pipes do not comply with the requirements, or if anomalies are found in laying and/or welding of the pipes, then the acceptance procedure will be provisionally suspended. The problems found will be analysed in consultation with the compound manufacturer, and an attempt will be made to find solutions which are acceptable to both parties. If this turns out to be impossible, then the compound will be considered as not accepted.

In such a case, the costs of the second stage could be charged to the compound manufacturer.

If the second stage of the procedure is successfully completed, then the compound is accepted and will be included in the list of "Approved PE Compounds". This list is published in the WGI specifications for PE pipes (11-0326-02-07-02-001 to 003) and PE fittings (11-0326-02-07-02-005). The materials will be included when the list is next published (around once every two year).

8. FOLLOW-UP

8.1. TECHNICAL DATA SHEET

The manufacturer must supply Owner/ owner representative with a technical data sheet, as described in Appendix 1, with permission for Owner/ owner representative to publish this technical data sheet in the specifications for PE pipes and fittings, for as long as the compound is included in the list of approved compounds.

The data entered on this data sheet apply as limit values for the compound concerned. Whenever one or more characteristics of a batch of compounds fall outside these limits, then the batch will be automatically refused for production of components destined for our gas network.

8.2. CONTINUITY OF THE COMPOUND

No alterations may be made to the compound without prior permission from Owner/ owner representative.

	POLYETHYLENE COMPOUNDS FOR MANUFACTURE OF PIPES AND FITTINGS FOR UNDERGROUND NETWORKS FOR NATURAL GAS DISTRIBUTION ACCEPTANCE PROCEDURE	DOCUMENT NO.	REV
		11-0326-07-02-005	0
		SHEET Page 10 of 12	

As mentioned in 8.1, the limits mentioned in the technical data sheet must be respected. Furthermore, in the case of characteristics not included in the technical data sheet, the measured values may not deviate by more than 30% from the average value mentioned in the technical file, to the extent that these are relevant and not in conflict with the requirements of the standard.

Each change that affects the final characteristics of the compound can result in additional tests being carried out by the compound manufacturer in accordance with the, provisions of prEN 1555-7 appendix A. The procedures for the test shall correspond to those described in section 6.1 of this specification.

	POLYETHYLENE COMPOUNDS FOR MANUFACTURE OF PIPES AND FITTINGS FOR UNDERGROUND NETWORKS FOR NATURAL GAS DISTRIBUTION ACCEPTANCE PROCEDURE	DOCUMENT NO.	REV
		11-0326-07-02-005	0
		SHEET Page 11 of 12	

APPENDIX 1

Technical Data Sheet

Characteristics of (name of PE compound) as per prEN 1555-1

Characteristics	Standard	Specification
MRS	EN ISO 12162	MPa
Density min. max.	Method D of ISO 1183	kg/rn ³ kg/rn ³
MFR190/5 mm. max.	ISO 1133	g/10 min g/10 min
Volatile content max.	prEN 12099	mg/kg
Water content max.	prEN 12118	mg/kg
Carbon black content Min. Max.	ISO 6964	% - %
Carbon black dispersion max	ISO 11420	<=Grade
OIT at 210°C min.	EN728	...min



Company

Person responsible

Position

Signature

	POLYETHYLENE COMPOUNDS FOR MANUFACTURE OF PIPES AND FITTINGS FOR UNDERGROUND NETWORKS FOR NATURAL GAS DISTRIBUTION ACCEPTANCE PROCEDURE	DOCUMENT NO.	REV
		11-0326-07-02-005	0
		SHEET Page 12 of 12	

	GREEN GAS LIMITED CITY GAS DISTRIBUTION PROJECT	
---	--	---

SUPPLEMENTARY PROCEDURE FOR TYPE APPROVAL OF POLYETHYLENE PIPES FOR UNDERGROUND GAS NETWORKS					CLIENT JOB NO.	
					TOTAL SHEETS	14
DOCUMENT NO	11	0326	02	07	02	007

--	--	--	--	--	--

0	30.12.11	ISSUED FOR TENDER	PD	SSJ	SB
A	16.11.11	ISSUED FOR CLIENT COMMENTS	PD	SSJ	SB
REV	DATE	DESCRIPTION	PREP	CHK	APPR

**SUPPLEMENTARY PROCEDURES FOR TYPE-APPROVAL OF POLYETHYLENE
PIPES FOR UNDERGROUND GAS NETWORKS**



**Supplementary Procedure for Type
approval of Polyethylene Pipes for
Underground Gas Networks**

DOCUMENT NO.

Rev

11-0326-07-02-007

0

Page 2 of 14

TABLE OF CONTENTS

1.	SUBJECT	4
2.	AREA OF APPLICATION	4
3.	REFERENCES	4
4.	DEFINITIONS	4
5.	PIPETYPE-APPROVAL TESTS	4
5.1.	GENERAL	4
5.2.	SIMPLIFYING PROVISIONS	5
5.2.1.	EXTRUSION LINES	5
5.2.2.	ROLLED PIPES – STRAIGHT PIPES	5
5.2.3.	PIPES WITH OPTIONAL MARKING	5
6.	TECHNICAL TYPE-APPROVAL FILE	5
	APPENDIX I — GENERAL INFORMATION	6
	APPENDIX 1.2. — EXTRUSION LINES	7
	APPENDIX 1.3.- LABORATORY EQUIPMENT	9
	APPENDIX 2— TEST PROGRAMME	11
1.	GENERAL	11
2.	RESIN TESTING	11
2.1.	BLACK RESIN	11
2.2.	YELLOW RESIN OR RESIN USED FOR COEXTRUDED MARKING	12
2.2.1.	TESTING OF PIPES	12
	APPENDIX 3—SEALS	14

	Supplementary Procedure for Type approval of Polyethylene Pipes for Underground Gas Networks	DOCUMENT NO.	Rev
		11-0326-07-02-007	0
		Page 3 of 14	

1. SUBJECT

This procedure supplements and defines the practical arrangements based on the provisions in technical specifications 11-0326-02-07-02-001 "Polyethylene pipes for underground networks for natural gas distribution", 11-0326-02-07-02-002 "Polyethylene pipes for underground networks for natural gas distribution — Technical data sheet" and 11-0326-02-07-02-003 "Polyethylene pipes for underground networks for natural gas distribution — Quality Control of pipes" for the purpose of type-approval of the product.

It defines the simplifying procedures applicable in certain conditions for type-approval of the pipes based on tests carried out on similar types in accordance with the methods of specification 11-0326-02-07-02-001, without repeating all the tests specified in the latter.

It stipulates the conditions for type-approval of the seals to be fitted on the pipes.

2. AREA OF APPLICATION

The procedure is applicable to type-approval of the pipe and of the seals as laid down in the Technical Specification 11-0326-02-07-02-001.

3. REFERENCES

- 11-0326-02-07-02-001 Polyethylene pipes for underground networks for natural gas distribution.
- 11-0326-02-07-02-002: Polyethylene pipes for underground networks for natural gas distribution — Technical data sheet.
- 11-0326-02-07-02-003: Polyethylene pipes for underground networks for natural gas distribution — Quality Control of pipes.
IS 14885 Polyethylene Pipes for the Supply of Gaseous Fuels-Specification

4. DEFINITIONS

Extrusion line:

The term extrusion line covers:

- the actual extruder and its tools (screw, die, etc.)
- the calibrators
- the delivery device (any material-drying device and gravimetric gauging system)
- the cooling system(s) (type of cooling, lengths of different tanks, etc.),
- any rolling device.

Batch of pipes:

See 11-0326-02-07-02-001§ 3.2.

Type of pipes

Type of pipes means pipes with the following identical characteristics:

- Nominal diameter
- Nominal thickness
- With or without optional marking (coextruded lines)
- Material
- Packaging (straight or rolled length)

5. PIPE TYPE-APPROVAL TESTS

5.1. GENERAL

Prior to type-approval, the information specified in the documents in Appendix 1 must be sent for the attention of the head of the Quality Control Department of the Owner/ owner representative or the

	Supplementary Procedure for Type approval of Polyethylene Pipes for Underground Gas Networks	DOCUMENT NO.	Rev
		11-0326-07-02-007	0
		Page 4 of 14	

recognised control organisation.

Type-approval tests on a type of pipes must be carried on all types of pipes intended for the Owner/owner representative for each extrusion line.

The pipe type-approval tests are defined in Appendix 2.

For the purposes of type-approval of a type of pipe, the main extrusion parameters for the pipes subjected to the type-approval tests are notified. These parameters must include in each case the extrusion rate expressed in kg/hour and the main limiting factor (e.g. cooling capacity, etc.).

The simplifying provisions in the following sections may be applied, however.

5.2. SIMPLIFYING PROVISIONS

5.2.1. Extrusion lines

If on the same production line using the same approved material, pipes of nominal diameter and nominal thickness, corresponding to the nominal maximum diameter and thickness manufactured at maximum rate Q1 in kg/h notified by the manufacturer have been type-approved,

and if

1) pipes of nominal diameter D2 and nominal thickness e2, corresponding to the nominal minimum diameter and thickness manufactured at the maximum rate Q2 in kg/h notified by the manufacturer have been type-approved, then pipes of diameter $D1 \leq D \leq D2$ and nominal thickness e1 shall be considered to be type-approved.

For each type-approved type of pipe, the manufacturer shall state the maximum extrusion rate for the extrusion line in question.

5.2.2. Rolled pipes-straight pipes

The provisions of section 5.2.1 also apply to rolled pipes.

The rolling diameter for type-approval is the minimum rolling diameter laid down in specification 11-0326-02-07-02-001

If a type of rolled pipe is type-approved, then straight pipes manufactured at the maximum rate Q1, using the same material, on the same line with the same nominal diameters and thicknesses, are type-approved. In this case the extrusion rate for the straight pipes must not exceed Q1.

5.2.3. PIPES WITH OPTIONAL MARKING

In addition to the test programme defined in § 5.1., the tests described in Appendix 2 must be carried out on samples of pipes to be type-approved.

The provisions of sections 5.2.1. and 5.2.2. also apply to pipes with optional marking.

If a type of pipe with optional marking is type-approved and if the rate of production of the latter is less than or equal to that of the type of pipe with marking, then the type of pipe without corresponding marking is type-approved.

6. TECHNICAL TYPE-APPROVAL FILE

The technical type-approval file includes the following documents and information:

- 1) General information listed in Appendices 1.1., 1.2. And 1.3.
- 2) Test reports as defined in section 5 and Appendix 2.
- 3) Information on seals as specified in Appendix 3.

	Supplementary Procedure for Type approval of Polyethylene Pipes for Underground Gas Networks	DOCUMENT NO.	Rev
		11-0326-07-02-007	0
		Page 5 of 14	

APPENDIX 1 - GENERAL INFORMATION

APPENDIX 1.1. — FACTORY

Work system Number of production teams Number of days' production per week	
<u>Total area occupied in m²</u>	
<u>Production bay in m²</u>	
PE pipes — packaging Straight lengths in crates Rolls of pipes Pipes rolled on drums	
Storage of granulate Bags Silos Octabins	
Handling methods Pipes Crates Drums	
Storage Crates: Covered or outdoor park Type of ground Handling and loading methods Rolls: Covered or outdoor park Type of ground Handling and loading methods Drums: Covered or outdoor park Type of ground Handling and loading methods Transport methods	
Manufacturer's drums Number of drums available at manufacturer's premises	

	Supplementary Procedure for Type approval of Polyethylene Pipes for Underground Gas Networks	DOCUMENT NO.	Rev
		11-0326-07-02-007	0
		Page 6 of 14	

APPENDIX 1.2. — EXTRUSION LINES

The following information must be provided for each extrusion line.

<p>Fusion Line</p> <p>Line no.</p> <p>Make</p> <p>Type</p> <p>Year of manufacture</p> <p>Screw length expressed in multiples of the diameter</p> <p>Screw diameter (in mm)</p> <p>Maximum diameter and thickness of pipe which can be produced by the extruder</p> <p>Minimum diameter and thickness of pipe which can be produced by the extruder</p> <p>Raw materials which can be extruded by the extruder</p> <p>Theoretical rate in kg/hour</p>	
<p>ASSOCIATED COEXTRUSION EQUIPMENT</p> <p>Make</p> <p>Type</p>	
<p>'DRYER</p> <p>Make and type</p>	
<p>CALIBRATOR</p> <p>Type</p> <p>Length</p>	

	<p>Supplementary Procedure for Type approval of Polyethylene Pipes for Underground Gas Networks</p>	DOCUMENT NO.	Rev
		11-0326-07-02-007	0
		Page 7 of 14	

<p>COOLING TANKS</p> <p>Number</p> <p>Length per tank</p>	
<p>MARKER</p> <p>Type</p>	
<p>DRAWER</p> <p>Type</p>	
<p>SA W</p> <p>Type</p>	
<p>CONTINUOUS THICKNESS MEASURING SYSTEM</p> <p>Operating principle</p> <p>Make</p> <p>Type</p> <p>Measurement recording equipment</p>	

	<p>Supplementary Procedure for Type approval of Polyethylene Pipes for Underground Gas Networks</p>	<p>DOCUMENT NO.</p>	<p>Rev</p>
		<p>11-0326-07-02-007</p>	<p>0</p>
		<p>Page 8 of 14</p>	

APPENDIX 1.3.- LABORATORY EQUIPMENT

<p>THICKNESS MEASURING SYSTEM</p> <p>Operating principle</p> <p>Make</p> <p>Type</p> <p>Accuracy of measurement</p> <p>Measurement recording equipment</p>	
<p>ANALYTICAL SCALES</p> <p>Make</p> <p>Type</p> <p>Accuracy</p>	
<p>DEVICE FOR MEASURING MELT MASS-FLOW RATE</p> <p>Make</p> <p>Type</p>	
<p>EQUIPMENT FOR MEASURING VOLATILE CONTENT</p>	
<p>EQUIPMENT FOR MEASURING WATER CONTENT -</p> <p>KARL FISCHER METHOD</p>	
<p>EQUIPMENT FOR MEASURING THERMAL STABILITY</p> <p>Make</p> <p>Type</p> <p>Recorder</p>	
<p>EQUIPMENT FOR MEASURING INTERNAL STRESSES</p> <p>Ovens</p> <p>Baths</p>	

	<p>Supplementary Procedure for Type approval of Polyethylene Pipes for Underground Gas Networks</p>	<p>DOCUMENT NO.</p>	<p>Rev</p>
		<p>11-0326-07-02-007</p>	<p>0</p>
		<p>Page 9 of 14</p>	

<p>RESISTANCE TO INTERNAL HYDRAULIC PRESSURE</p> <p>Baths at 20°C (maximum number of samples for diameters 110mm and 250 mm)</p> <p>Baths at 80°C (maximum number of samples for diameters 110mm and 250 mm)</p> <p>Number of head pairs available for each diameter</p>	
<p>TRACTION MACHINE</p> <p>Make</p> <p>Type</p> <p>Capacity</p> <p>Accuracy</p>	
<p>WELDING MACHINE</p> <p>Make and type</p>	

	<p>Supplementary Procedure for Type approval of Polyethylene Pipes for Underground Gas Networks</p>	<p>DOCUMENT NO.</p>	<p>Rev</p>
		<p>11-0326-07-02-007</p>	<p>0</p>
		<p>Page 10 of 14</p>	

APPENDIX 2- TEST PROGRAMME

1. GENERAL

If the manufacturer does not have the equipment to carry out these tests properly, they shall be carried out at the manufacturer's expense in a laboratory chosen by the Owner/ owner representative.

2. RESIN TESTING

The following tests and checks must be carried out on a representative sample of the batch of raw material. In addition, the manufacturer must keep an adequate sample (± 1 kg) of granulate for any repeat tests.

2.1 BLACK RESIN

TABLE OF TESTS ON MATERIALS

Test	Quality criterion as per specification 11-0241-02-07-02-001	Test method as per specification 11-0241-02-07-02-001	Number of samples per batch
Density	§ 5.2.1.3	§ 6.2.	1
Melt mass-flow rate	§ 5.2.1.4	§ 6.3.	1
Volatile content	§ 5.2.1.5	§ 6.4.	1
Water content	§5.2.1.6	§6.5.	1
Pigment dispersion	§ 5.1.8.	As per Annex E of IS 14885	1
Thermal stability	§ 5.2.7.	§ 6.6	1

	Supplementary Procedure for Type approval of Polyethylene Pipes for Underground Gas Networks	DOCUMENT NO.	Rev
		11-0326-07-02-007	0
		Page 11 of 14	

2.2 YELLOW RESIN OR RESIN USED FOR COEXTRUDED MARKING

TABLE OF TESTS ON MATERIALS

Test	Quality criterion as per specification 11-0241-02-07-02-001	Inspection method as per specification 11-0241-02-07-02-001	Number of samples per batch
Density	§ 5.2.1.3	§ 6.2.	1
Melt mass-flow rate(M5l)	§ 5.2.1.4	§ 6.3.	1
Volatile content	§ 5.2.1.5	§ 6.4.	1
Water content	§5.2.1.6	§6.5.	1
Pigment dispersion	§ 5.1.8.	As per Annex E of IS 14885	1
Thermal stability	§ 5.2.7.	§ 6.6	1

2.2.1 TESTING OF PIPES

The following tests and checks must be carried out on representative samples of pipes manufactured using the same batch of raw material on a given extrusion line at its maximum rate.



	Supplementary Procedure for Type approval of Polyethylene Pipes for Underground Gas Networks	DOCUMENT NO.	Rev
		11-0326-07-02-007	0
		Page 12 of 14	

TABLE OF TESTS ON PIPE SAMPLES

Test	Quality criterion as per specification 11-0241-02-07-02-001	Test method as per specification 11-0241-02-07-02-001	Number of samples per batch	Number of test specimen	
				Per sample	Per batch
Appearance-dimensions-marking					
Internal stresses	§ 5.2.2.1.	§ 6.8	2	3 from the same pipe	6
Determination of Traction Characteristics	§ 5.2.2.5.	§ 6.12	2	3 from the same pipe	6
Melt mass-flow rate	§ 5.2.1.4.	§ 6.3	2	1 from the same pipe	2
Resistance to internal hydraulic pressure	§ 5.2.2.2.	§ 6.9			
at 20°C			1	2 test specimens (+ 2 reserves) 1 test specimen per pipe	4
at 80°C	1	2 test specimens (+ 2 reserves) 1 test specimen per pipe	4		
Weldability (applicable to pipes with external diameter of 90 mm or more)	§ 5.2.2.6	§ 6.13	2	2 sections of different pipes welded end to end	4
Appearance and dimensions	§ 5.2.2.6	§ 6.13.1			
Resistance to internal hydraulic pressure	§ 5.2.2.2	§ 6.13.2. + 6.9.			
at 20°C			1	1 test specimen of welded pipes	
at 80°C	1	1 test specimen of welded pipes			
Traction on welded pipe	§ 5.2.2.6	§ 6.13.3	1	1 welded sample	2
Resistance to growth of cleavage fracture (applicable to pipes with external diameters of 110 mm or more) (1)	§ 5.2.2.4.	§ 6.11	1	4 section of the same pipe	4
Thermal stability of PE	§ 5.2.1.7.	§ 6.6	1		1

	Supplementary Procedure for Type approval of Polyethylene Pipes for Underground Gas Networks	DOCUMENT NO.	Rev
		11-0326-07-02-007	0
		Page 13 of 14	



Resistance to atmospheric influence	§ 5.2.1.8.	§ 6.7	under study
-------------------------------------	------------	-------	-------------

(1)The pipe is considered to be resistant when the length of the crack formed during the test remains smaller than the nominal diameter of the pipe. Failing this, the rate of growth of the crack must steadily decline.

APPENDIX 3—SEALS

Seals must comply with the requirements defined in section 8.4. of specification 11-0326-02-07-02-001 The manufacturer shall supply drawings stating seal tolerances and the material from which the seals are made.

	Supplementary Procedure for Type approval of Polyethylene Pipes for Underground Gas Networks	DOCUMENT NO.	Rev
		11-0326-07-02-007	0
		Page 14 of 14	

	GREEN GS LIMITED CITY GAS DISTRIBUTION PROJECT	
---	---	---

POLYETHYLENE PIPES					CLIENT JOB NO.	
					TOTAL SHEETS	05
DOCUMENT NO	11	0326	02	07	02	024

--	--	--	--	--	--

0	30.12.11	ISSUED FOR TENDER		PD	SSJ SB
A	16.11.11	ISSUED FOR CLIENT COMMENTS		PD	SSJ SB
REV	DATE	DESCRIPTION		PREP	CHK APPR

TECHNICAL SPECIFICATION FOR POLYETHYLENE PIPES



POLYETHYLENE PIPES

DOCUMENT NO.

Rev

11-0326-02-09-02-024

0

Page 2 of 5

TABLE OF CONTENTS

1.	INTRODUCTION & SCOPE	4
2.	DEFINITIONS	4
3.	PIPE SIZES	4
4.	LENGTH OF PIPES	4
5.	COLOUR	4
6.	MARKING	4
7.	HANDLING AND STORAGE	5
8.	QUALITY ASSURANCE (QA)	5



POLYETHYLENE PIPES

DOCUMENT NO.

Rev

11-0326-02-09-02-024

0

Page 3 of 5

1 INTRODUCTION & SCOPE

The present Specification relates to the manufacture of "Polyethylene Line Pipes" for the CUGL City Gas Distribution Project.

The present Specification has to be read in conjunction with Technical Specifications 011-0326-02-07-02-001, 002, 003, 004.

The present specification confirms, completes or modifies certain sections/paragraphs of the said General Technical Specifications.

2. DEFINITIONS Owner/Purchaser/Client/Owner Representative: Company: means CUGL Manufacturer means the Manufacturer of the pipes as well as its sub-contractor(s). Third Party Inspection Agency means the Inspection Agency to be appointed by CUGL Bidder means the party quoting for the pipes.

3. PIPE SIZES (REF. CL. 5.2.3.1 OF 011-0326-02-07-02-001)

Nominal Dia Di	Thickness	Material
• 20mm	SDR11	PE100 Polyethylene
• 32mm	SDR11	PE100 Polyethylene
• 63mm	SDR11	PE100 Polyethylene
• 90mm	SDR11	PE100 Polyethylene
• 125mm	SDR11	PE100 Polyethylene

4. LENGTH OF PIPES (REF. CL. 8.2 OF 011-0326-02-07-02-001)

The required minimum lengths are as follows:

Nominal Dia	Lengths
20 mm	100 mtrs
32 mm	100 mtrs
63mm	100 mtrs
90mm	50 mtrs
125mm	50 mtrs

5. COLOUR (REF. CL. 5.2.1.2 OF 011-0326-02-07-02-001)

The pipe shall be of ORANGE colour.

6. MARKING

Owner's/Owner Representative name as CUGL be marked on each pipe.

	POLYETHYLENE PIPES	DOCUMENT NO.	Rev
		11-0326-02-09-02-024	0
		Page 4 of 5	

7. HANDLING AND STORAGE

Packaging shall be done in Hessian cloth (Jute) to avoid direct sunlight and facilitate out-door storage.

8. QUALITY ASSURANCE (QA) (REF. CL. 3.2 OF 011-0326-02-07-02-003)

Manufacturer to submit QA system for the approval of Owner /Owner Representative.



POLYETHYLENE PIPES

DOCUMENT NO.

Rev

11-0326-02-09-02-024

0

Page 5 of 5